

PORTES

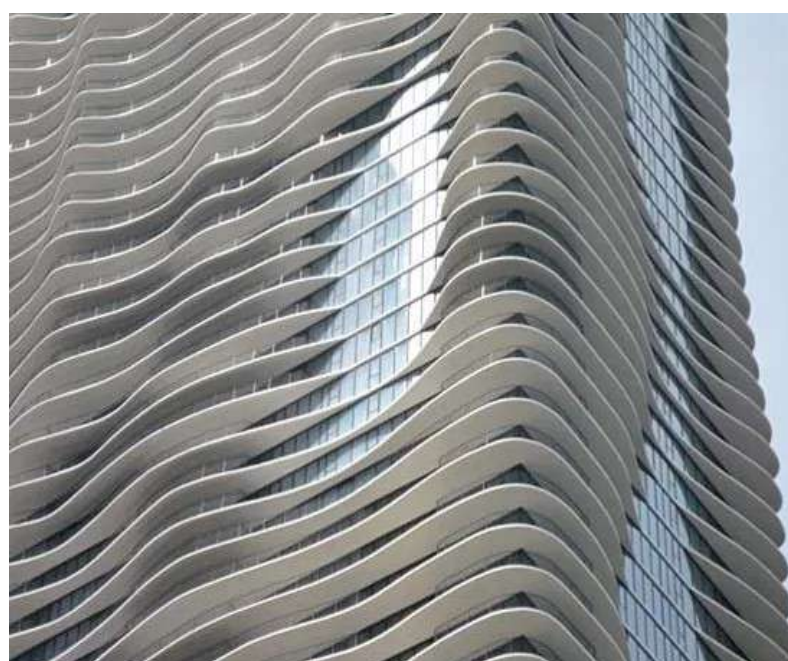
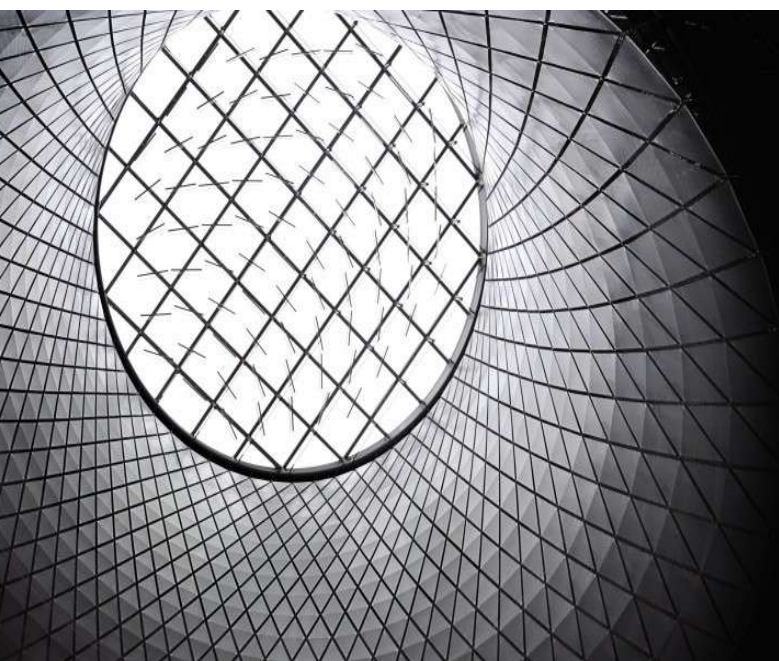
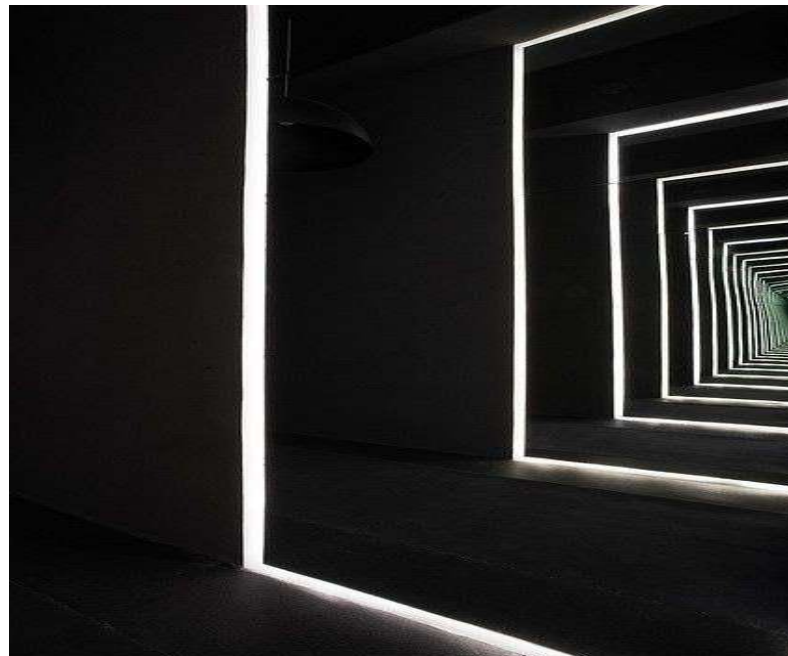
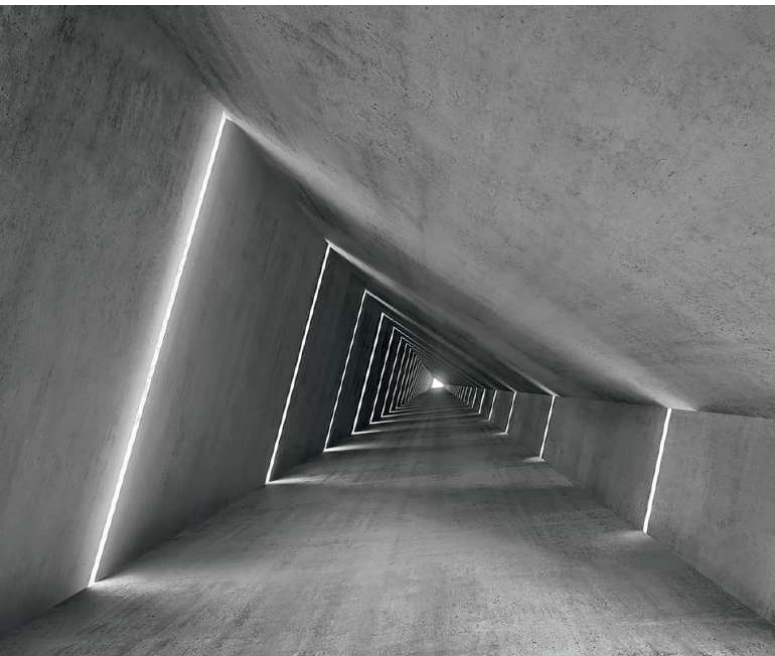

ALU210
.COM

Sublimez votre maison.

3 – 4	PRÉSENTATION
5 – 9	PORTÉO-TERMIC, LA PORTE MONOBLOC
10 – 15	LES COULEURS
16 – 24	NOS COLLECTIONS
25 – 31	Collection LES AUTHENTIQUES
32 – 38	Collection LES ESSENTIELS
39 – 45	Collection LES DESIGNS
46 – 51	Collection LES CREATIONS
94 – 103	ACCESSOIRES
104 – 105	VITRAGES

ALU210, une écoute à toutes vos envies !

Après 20 ans d'expérience, les collections de panneaux d'ALUPRO reflètent innovation et savoir-faire

➤ Des produits 100% sur-mesure !

Nos produits sont fabriqués dans notre usine située en Espagne.
Tout est travaillé, transformé, façonné, pour donner vie à des collections variées.
Modernisation des moyens de production, produits innovants et performants, des outils d'aide à la vente (tarifs , catalogues, outils d'aide à la vente , rool-up, drapeau, comptoir..).

➤ Des outils de dernière génération CNC

ALU210 possède aujourd'hui des équipements de production de dernières générations, une équipe qualifiée qui permet une gestion des délais performante .

➤ Une équipe pour vous satisfaire

Chez ALU210, on cultive l'amour du travail bien fait et la synergie des compétences.
Le professionnalisme est plus que jamais d'actualité et se décline dans tous les métiers de l'entreprise. Qu'il s'agisse de concevoir, fabriquer, mobiliser les équipes, ALU210 met tous les moyens en œuvre pour vous proposer des produits à la hauteur de vos exigences.

PORTÉO-THERMIC

PORTE MONOBLOC

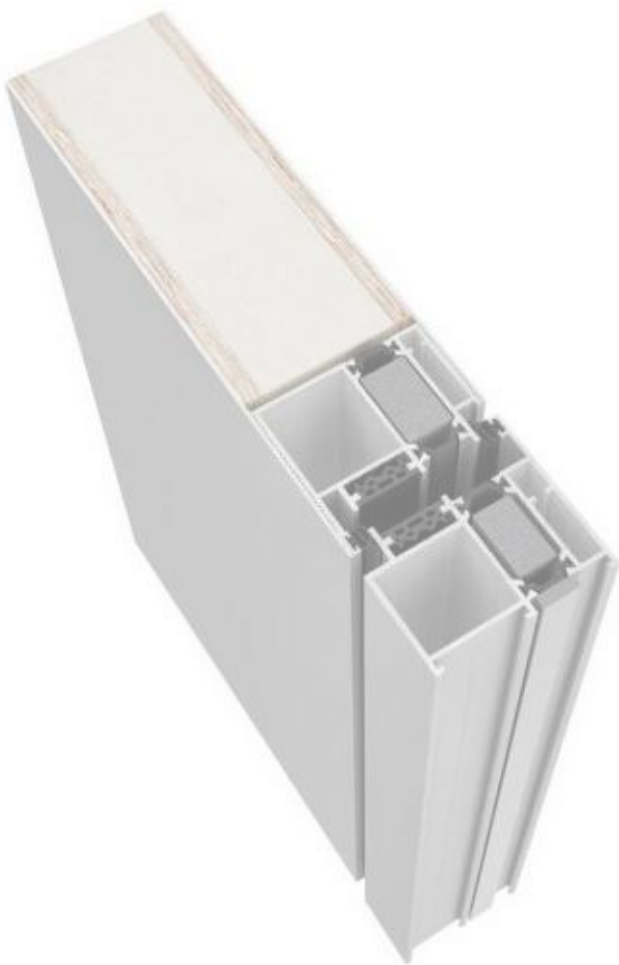

Up
0.79 W/m².K





INFORMATION TECHNIQUE

OUVRANT	DE 70 mm AVEC RUPTURE DE PONT THERMIQUE, TÔLE ALUMINIUM DE 3.0 MM
INTÉRIEUR	XPS DE HAUTE DENSITÉ kg/m^3 , RÉSISTANCE À LA COMPRESSION 300 kPa
DESIGN	5 GAMMES : LIGHT, WOOD, PURE, VINTAGE, NEO-RETRO
VITRAGE	TRIPLE VITRAGE 60MM
ACCESSOIRES	SELON MODÈLE
DIMENSIONS	STANDARD ET SUR MESURES
POIDS PAR VANTAIL	JUSQUE 250 KG
COEF	U_w 0,79 (Wtrk)
ACOUSTIQUE	R_w = 40 dB.
ÉPAISSEUR PROFIL	2,0 mm

PERFORMANCE ACOUSTIQUE

VITRAGE: 64 mm.

AFFAIBLISSEMENT ACOUSTIQUE: $R_w = 40$ dB.

LIMITES DIMENSIONNELLES

PORTE PAUMELLES STANDARD

LARGEUR (L) = 1.300 mm

HAUTEUR (H) = 2.400 mm

PORTE PAUMELLES INVISIBLES

LARGEUR (L) = 1.150 mm

HAUTEUR (H) = 2.300 mm

RÉSULTATS BANC D'ESSAI

perméabilité à l'air (UNE-EN 12207:2000) : **Classe 4**

Étanchéité à l'eau (UNE-EN 12208:2000): **Classe 6A**

Résistance au vent (UNE-EN 12210:2000): **Classe C4**

Test de référence 1,20 x 2,30 m. 1 vantail.

Résistance aux impacts (UNE-EN 13049:2003): **Classe 5 (máx)**

Test de référence porte 1,80 x 2,20 m.

résistance aux ouvertures et fermetures répétées (UNE-EN 1191: 2.500.000 cycles)

Test de référence porte 0,935 x 2,20 m. 1 vantail

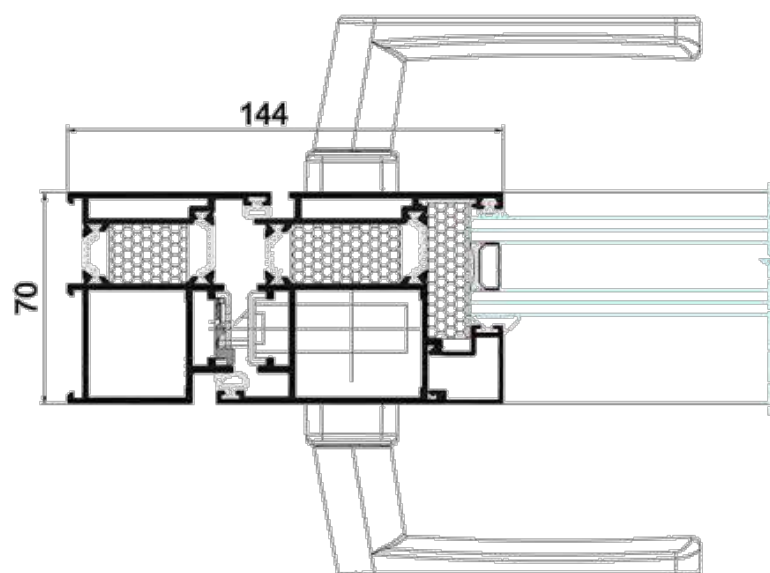



TYPES D'OUVERTURES

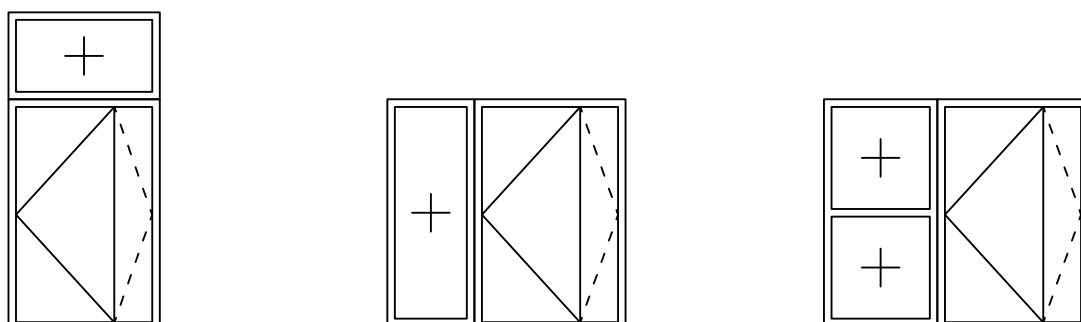
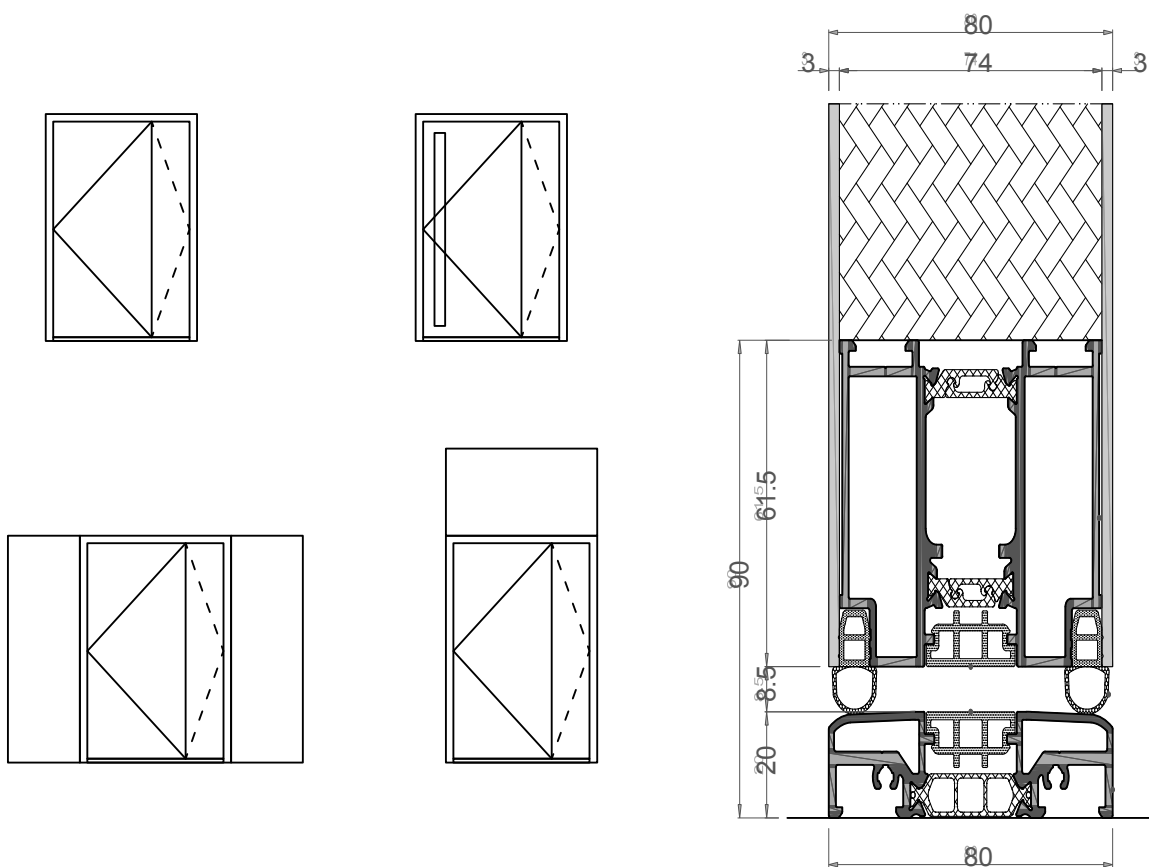

ALU210
.COM



La couleur

“ Nous vous proposons un choix de couleurs ”

Afin d'optimiser son process et de croître en réactivité, **ALU210** travaille avec une unité de laquage dernière génération qui respecte les normes de respect de environnementales, le tout au normes QUALICOAT, QUALIMARINE, et QUALINODE.

Les laquages 2 finitions

Finition **mate** (inférieure à 40 % de brillance)
Finition **satinée** (60 à 70 % de brillance)



Les laquages fines textures

Une large palette de teintes qui offre une meilleure résistance aux risques de rayures.



La couleur !
Choisissez le savoir-faire
ALU210.COM

Bicoloration

Jouez la carte de la fantaisie avec un duo de couleurs sur un même produit
Un coloris extérieur différent de celui intérieur sans contrainte ni limite de teintes.



Couleurs standard

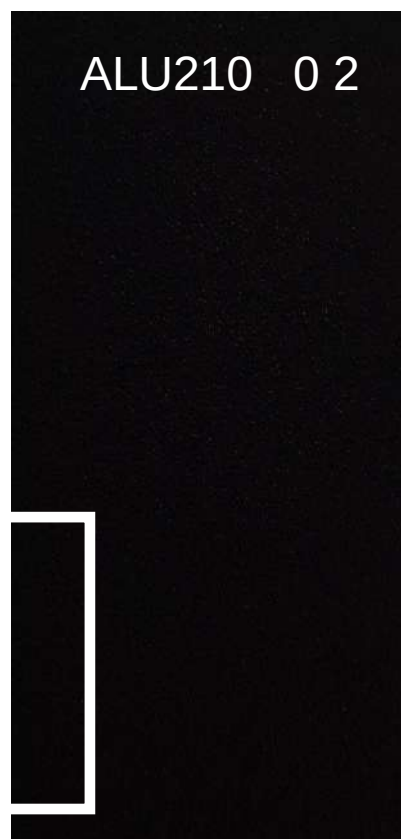
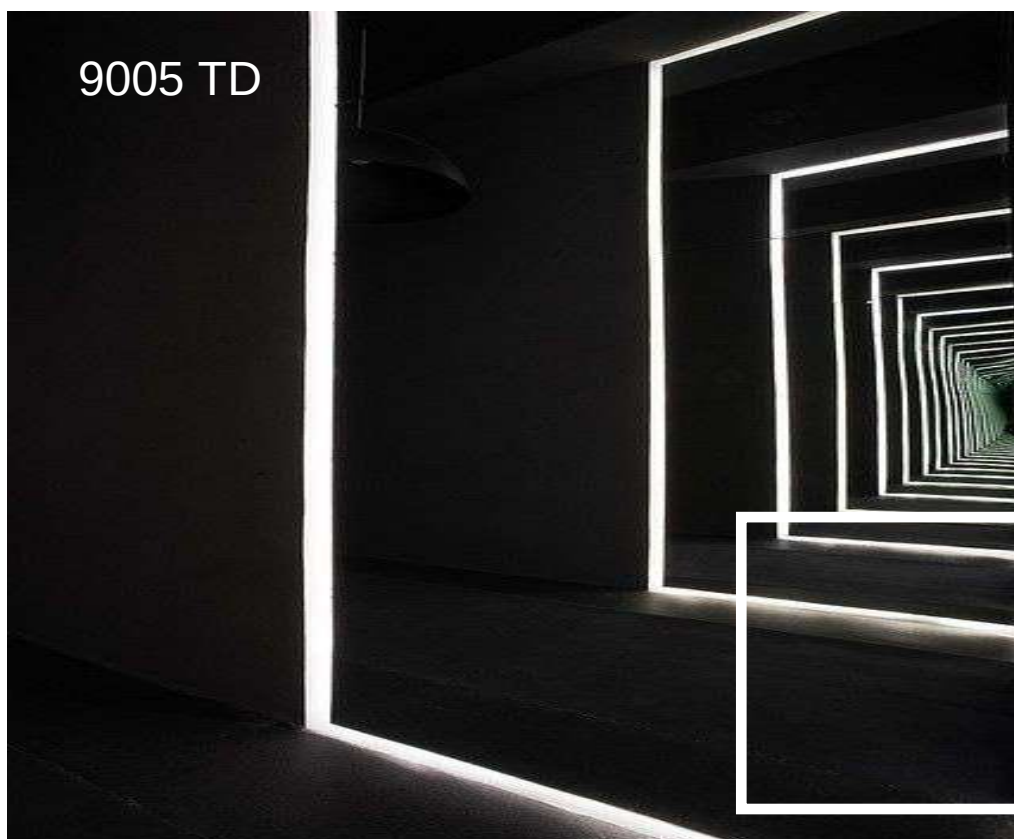

ALU210 0 3

7035 TD

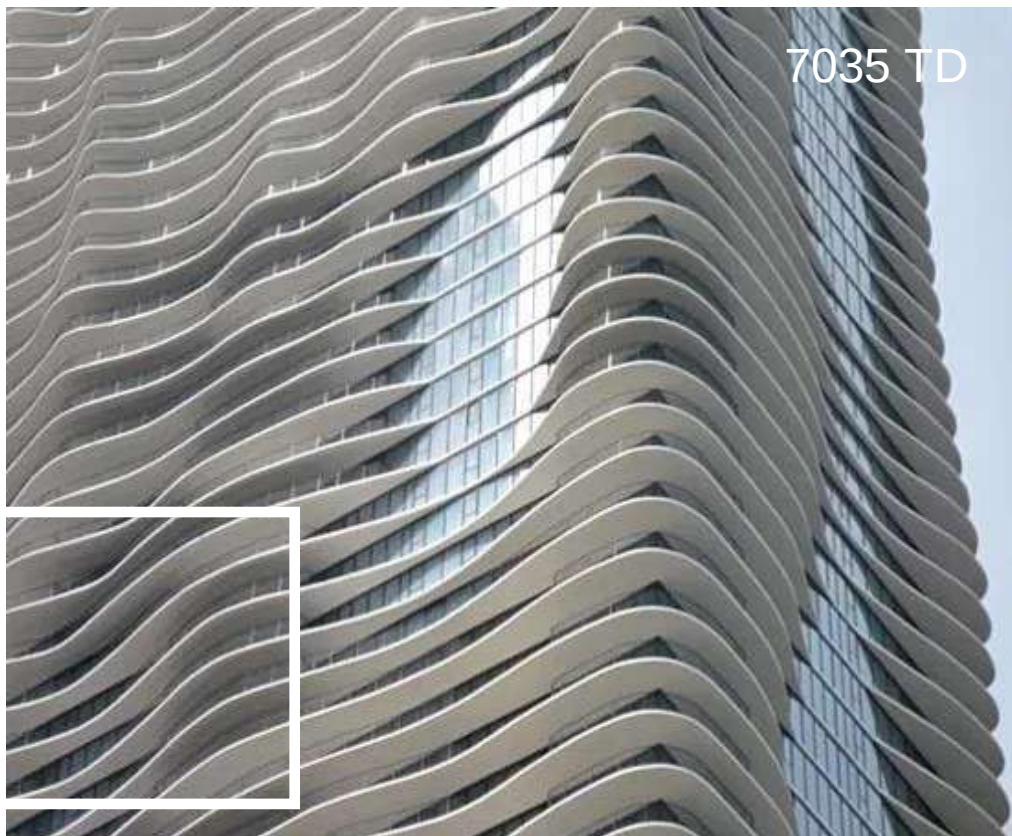

ALU210 0 4

7039 TD

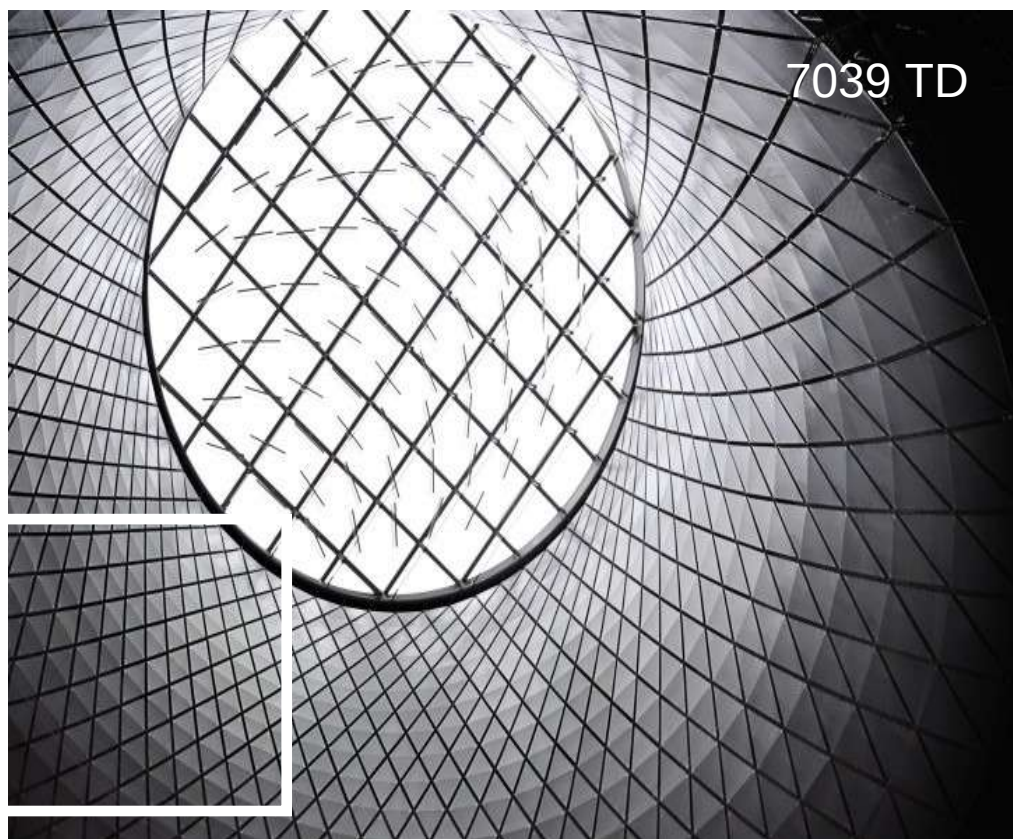

Couleurs TENDANCES

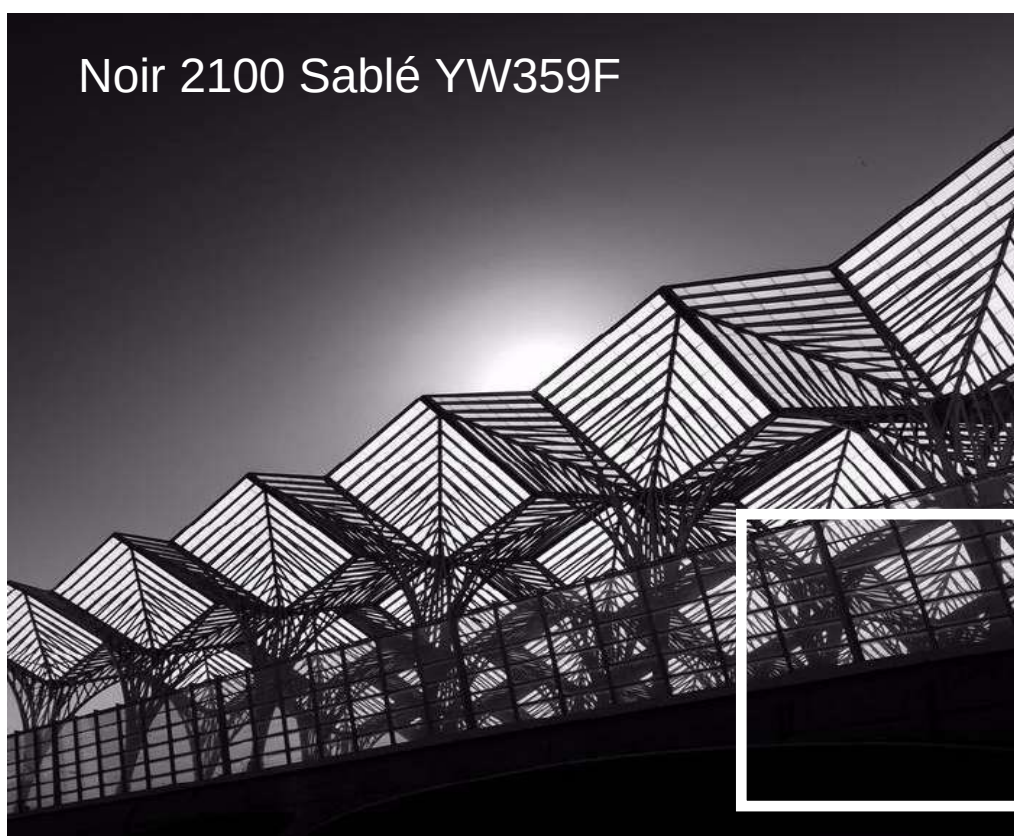

ALU210 07

Gris 2150 Sablé YW365F

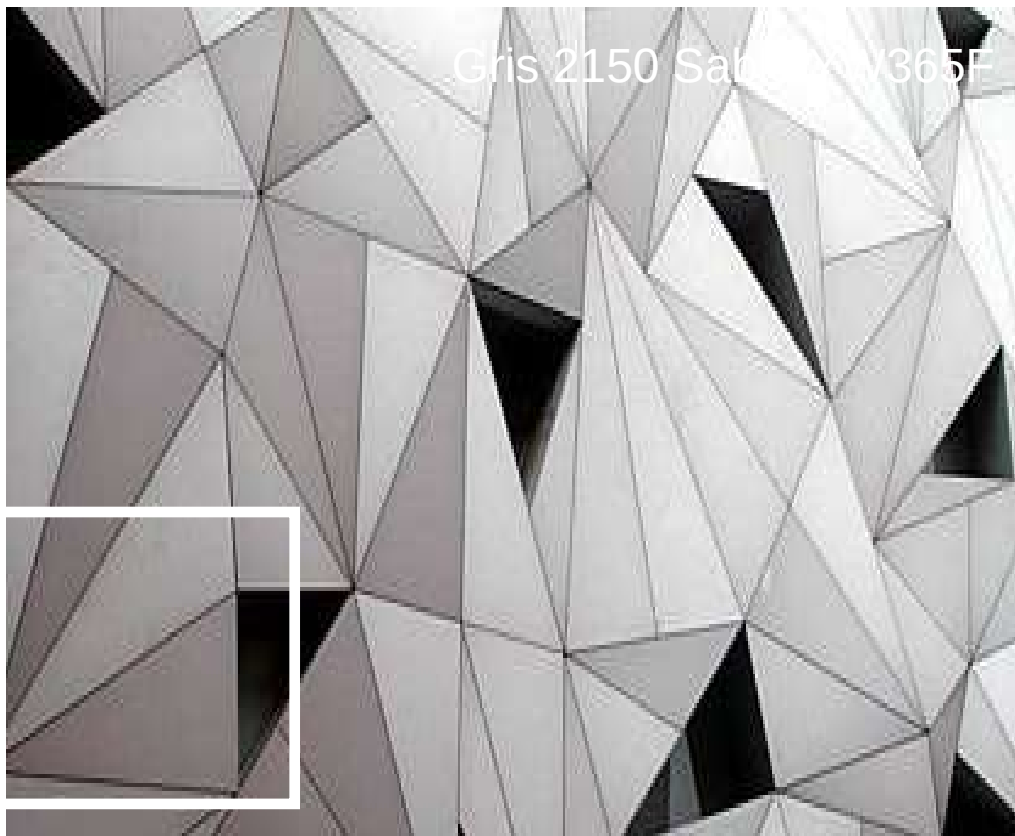

ALU210 08

Brun 2650 Sablé YW366F



La couleur / le plaxage

une solution innovante

Depuis quelques années les fenêtres en PVC n'étaient proposées qu'en blanc. Aujourd'hui, l'offre s'enrichit de teintes de plus en plus audacieuses. En effet, Les maîtres d'ouvrage et architectes peuvent aujourd'hui laisser libre cours à leur imagination grâce à une large palette de finitions décoratives, permettant ainsi de sublimer les éléments du bâtiment tout en les protégeant durablement des intempéries. Soucieux de la satisfaction de nos clients, nous élaborons depuis plus de 20 ans des films de plaxage décoratifs à la pointe de la technologie. Au fur et mesure des années, notre technologie exclusiveskai® cool colors a su s'imposer comme « LA » référence en terme de performance thermique et de durabilité. En étroite collaboration avec les instituts de normalisation tel que le RAL et le CSTB, nous contribuons à l'élaboration de directives de qualité ainsi qu'au développement de nouvelles technologies.

Cool colors : une technologie révolutionnaire

Les teintes sombres ont pendant des années été bannies des offres couleurs dues à leur fort coefficient d'absorption. Dans un souci de satisfaire nos clients et face à la demande grandissante du marché, nous avons conçu et breveté la technologie skai® cool colors. Des pigments froids intégrés dans la base de nos films permettent de limiter considérablement l'impact thermique du rayonnement solaire. Cette technologie minimise la température des profilés ainsi que la dilatation ou déformation de ceux-ci. Les films skai® cool colors protègent vos fenêtres tout en contribuant à leur longévité.

La fenêtre de demain

En partenariat avec l'institut de normalisation Allemand RAL et en relation étroite avec nos clients, nous ne cessons de perfectionner nos films, apportant ainsi notre contribution à l'élaboration de la fenêtre de demain. Les nouveaux critères d'essai et de qualité RAL prescrivent désormais une exposition aux intempéries de 10.000 heures au minimum, un niveau jamais atteint précédemment. Volontairement, nous avons décidé de porter ce niveau à 15.000 heures. Afin d'optimiser nos futurs développements, nous entretenons d'étroites relations et des échanges réguliers avec les différents acteurs du marché. Confiant des produits que nous proposons nous avons étendu nos garanties à 10 ans dans tout le monde.



cool  tp60
colors
by Hornschuch

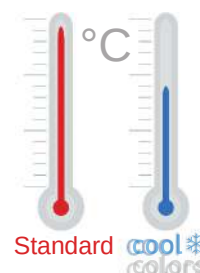

Continental 
The Future in Motion

skai

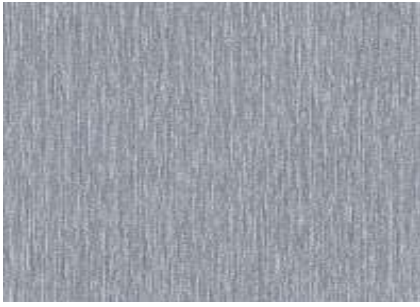

F4361001
Metbrush aluminium



F4361002
Metbrush silver

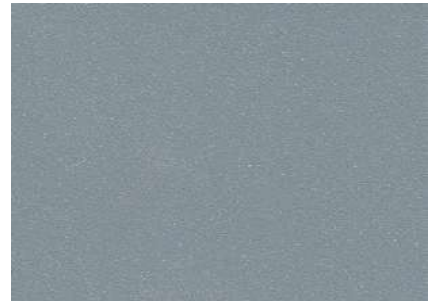

F4361013
Alux silbergrau



F4361014
Alux DB 703



F4366055
s-bronze matt



F4366047
quarzgrau matt



F4563081
Sheffield Oak light



F4363087
Sheffield Oak brown



F4363086
Sheffield Oak grey





WINCHESTER



ALU210 09



CHÊNE DORÉ

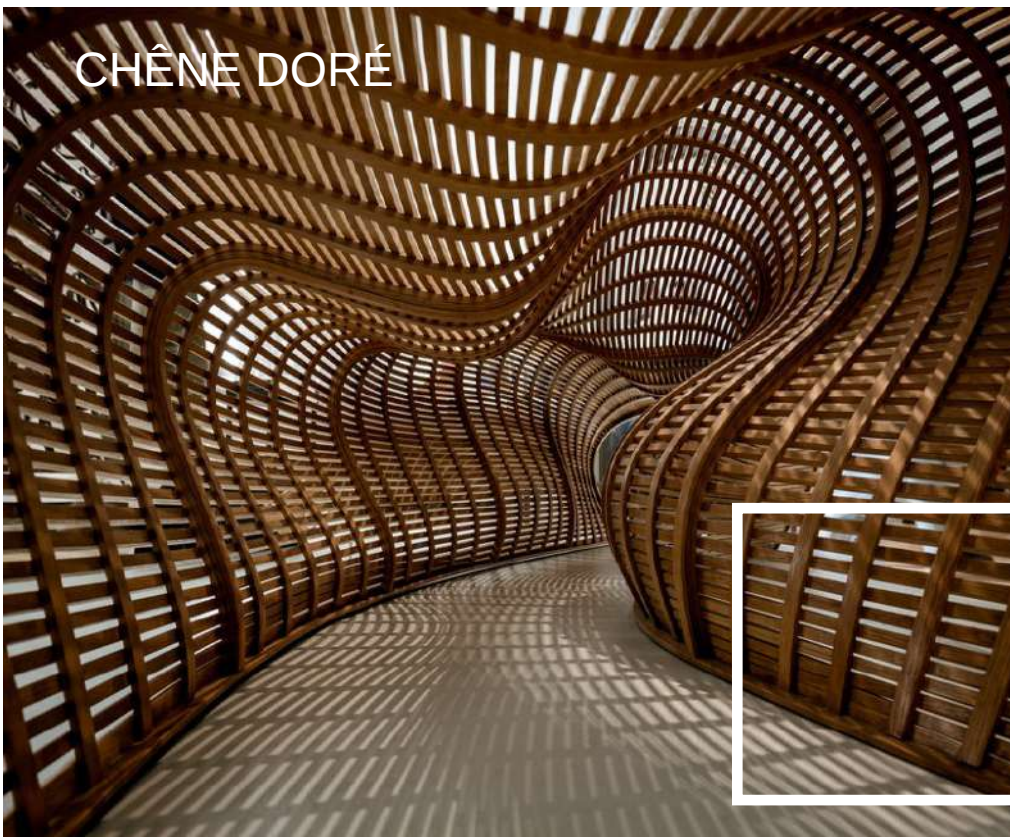

ALU210 10





AUTHENTIQUE

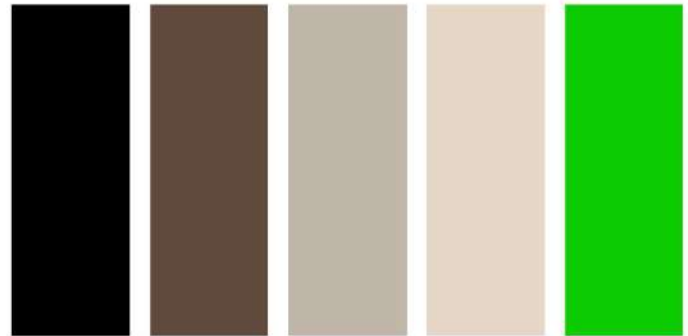
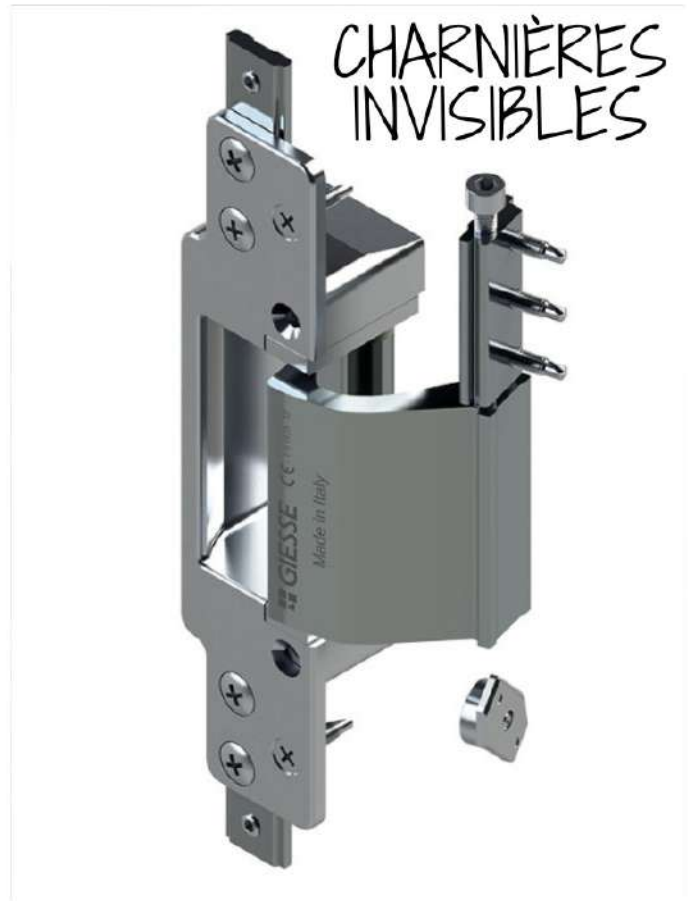

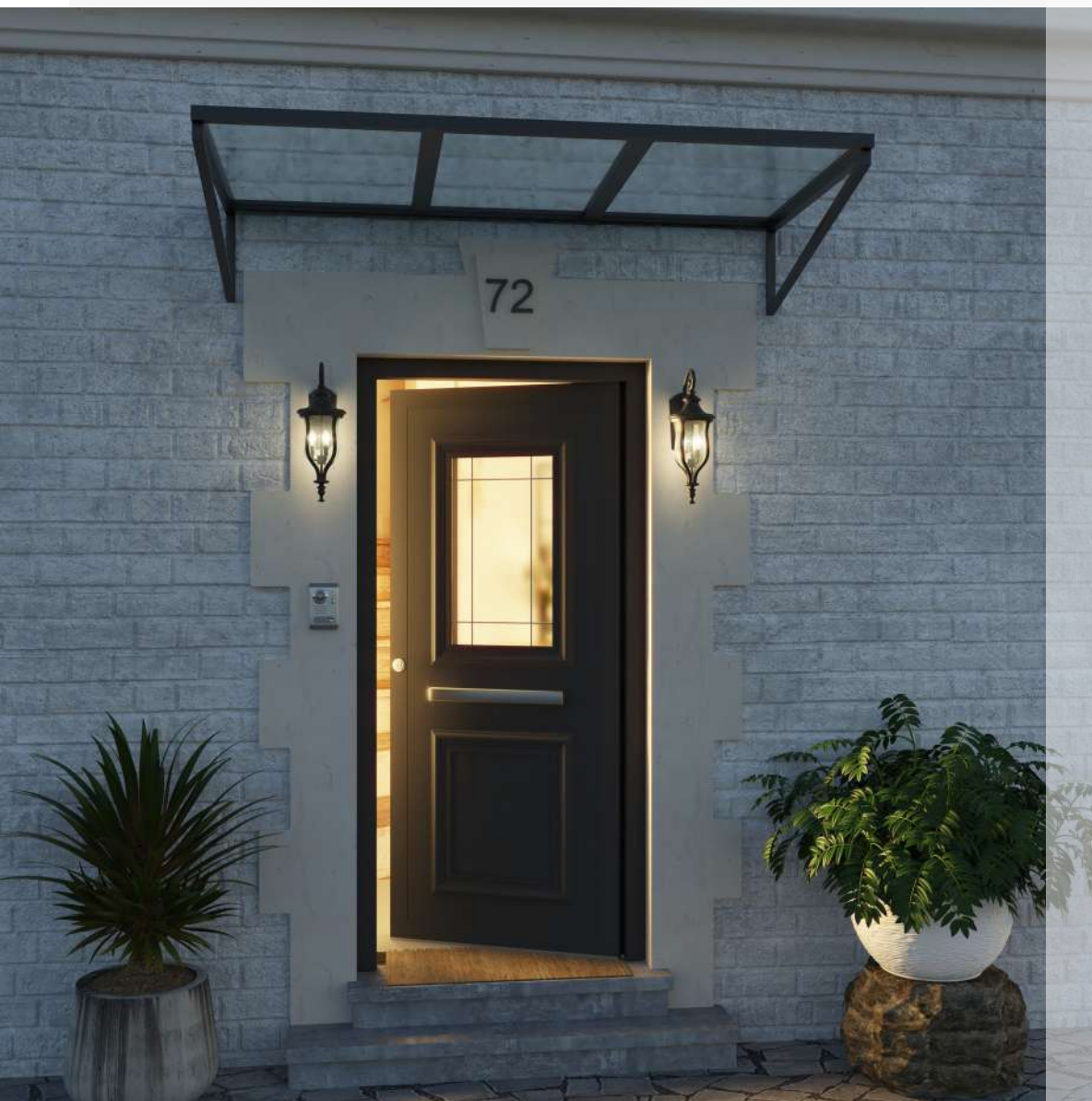

ORLÉANS | VINTAGE LINE

Porte ral 9005 texturé
Verre petits bois inox
Porte ouvrant 76mm
Barre de tirage D-19
Serrure 3 ou 5 points winkhaus
Seuil PMR
Paumelles invisible
Système anti effraction

Options:

- Rals
- Bicoloration
- Rosace décorative
- Cimaises



AUTHENTIQUE



ORLÉANS



TOURS



TOULOUSE



AMIENS



LILLE

GAMME AUTHENTIQUE

Porte monobloc, charnières invisible, système anti-dégondage de série







*E*SSENTIELS

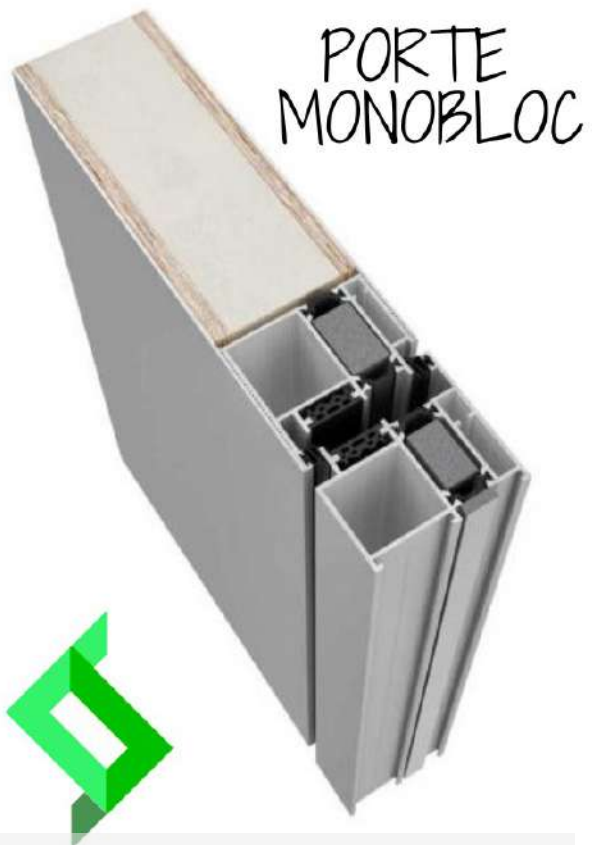
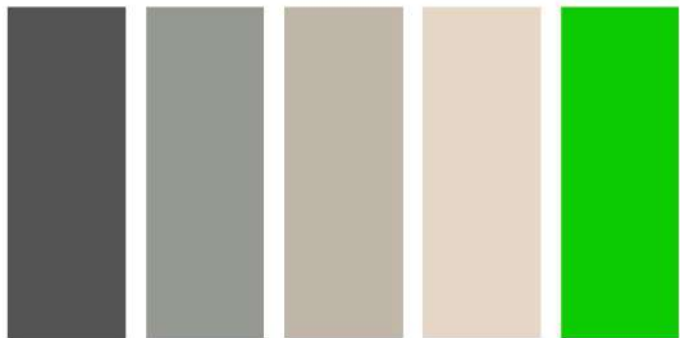
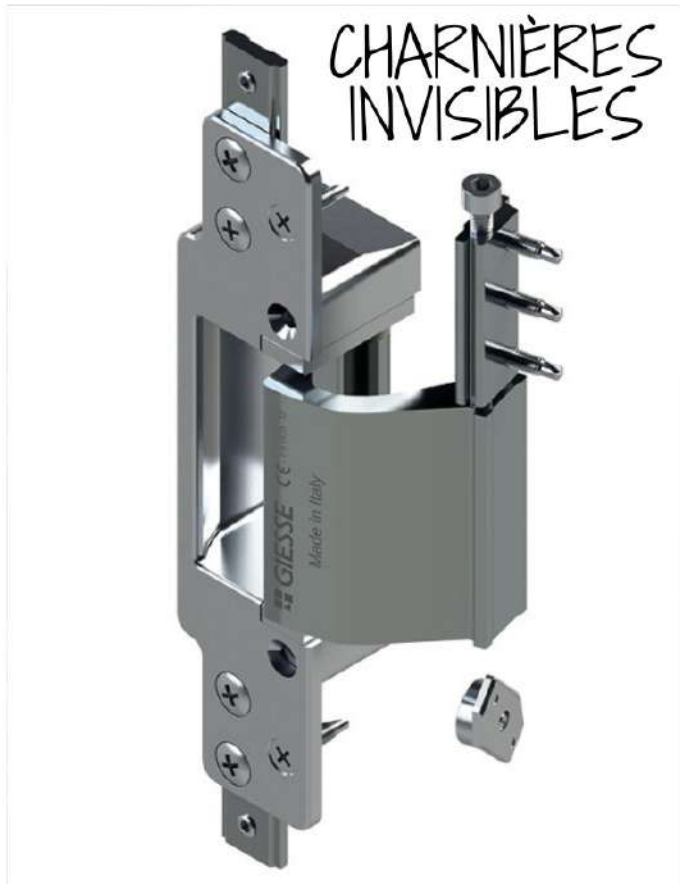

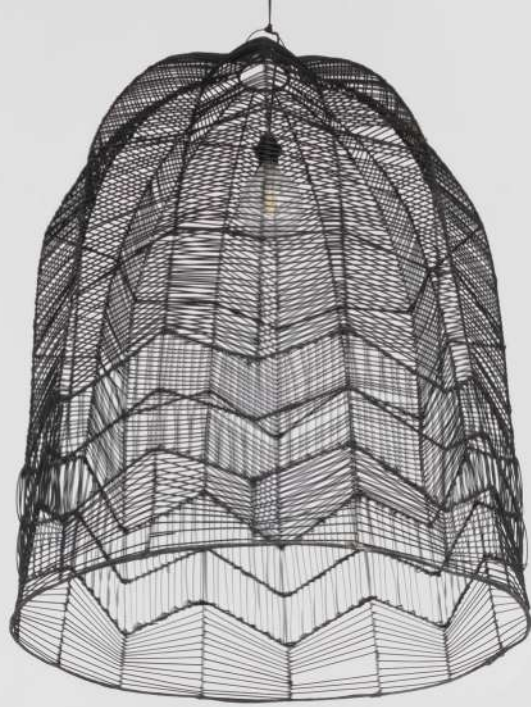

ESSENTIELS



MEUSE



SEINE



GARONNE



LOIRE



RHONE

GAMME ESSENTIELS

Porte monobloc, charnières invisible, système anti-dégondage de série







12

12



*D*ESIGN

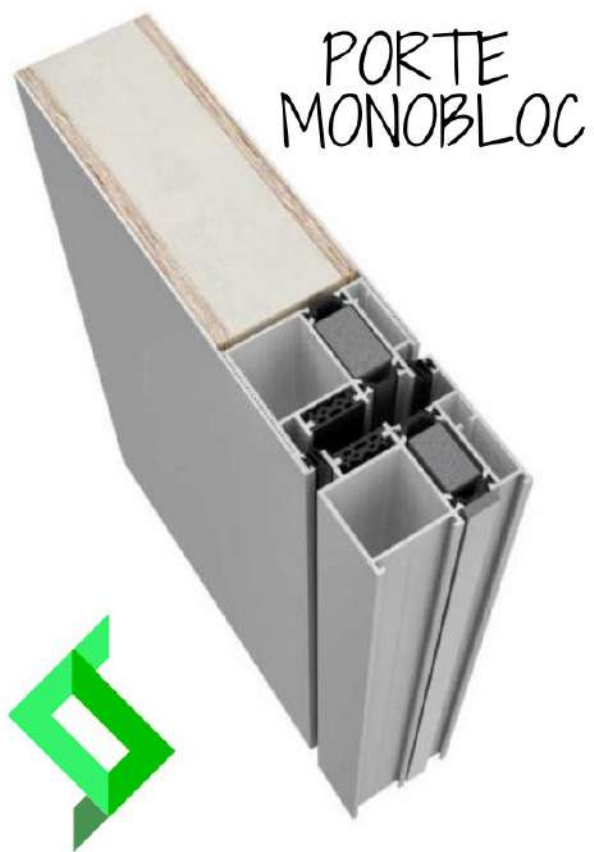
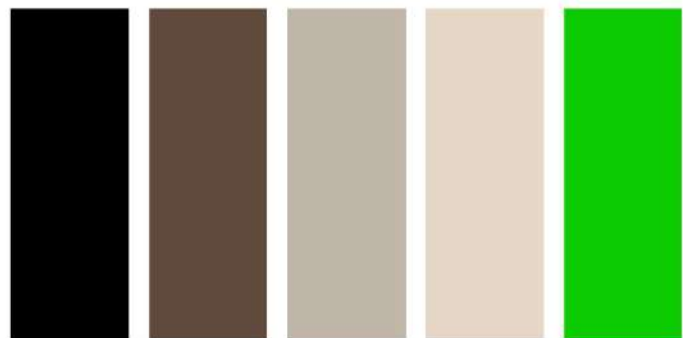

DESIGN



MEUSE



SEINE



GARONNE

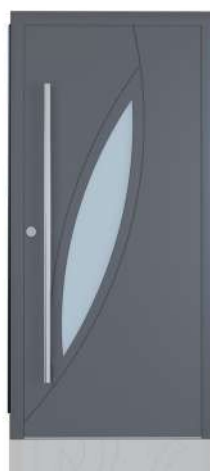

LOIRE



RHONE

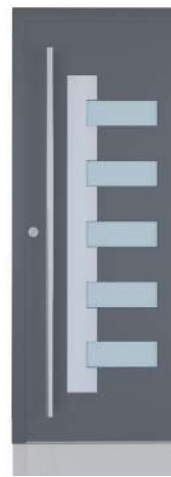

AVIGNON

GAMME DESIGN

Porte monobloc, charnières invisible, système anti-dégondage de série





3





CRÉATION



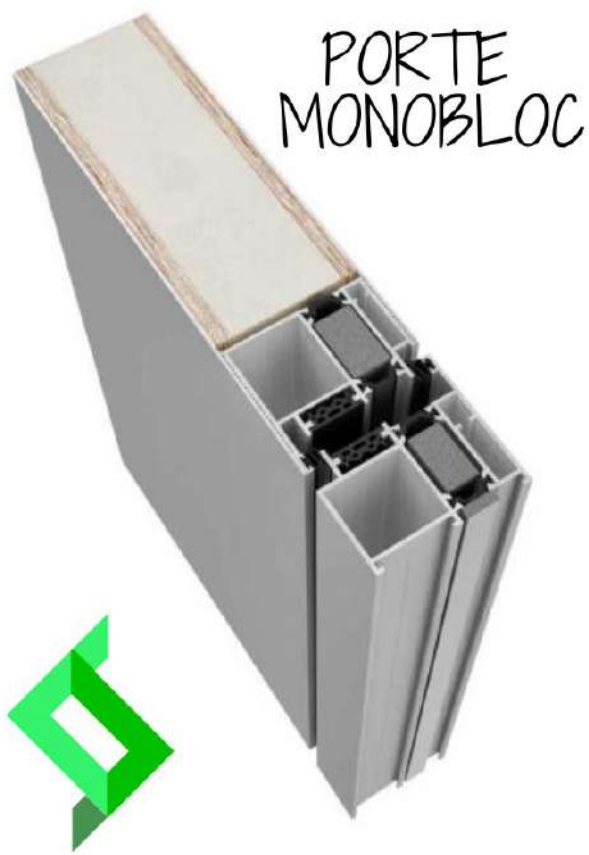
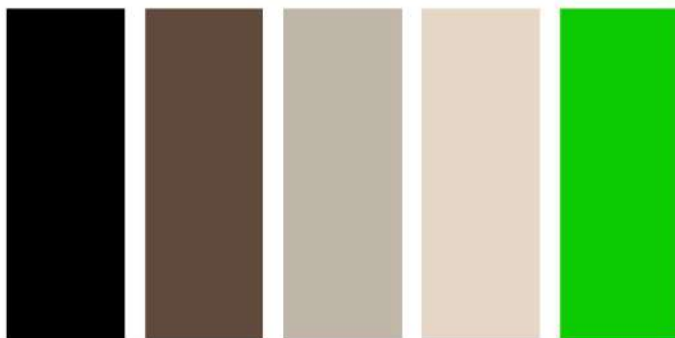
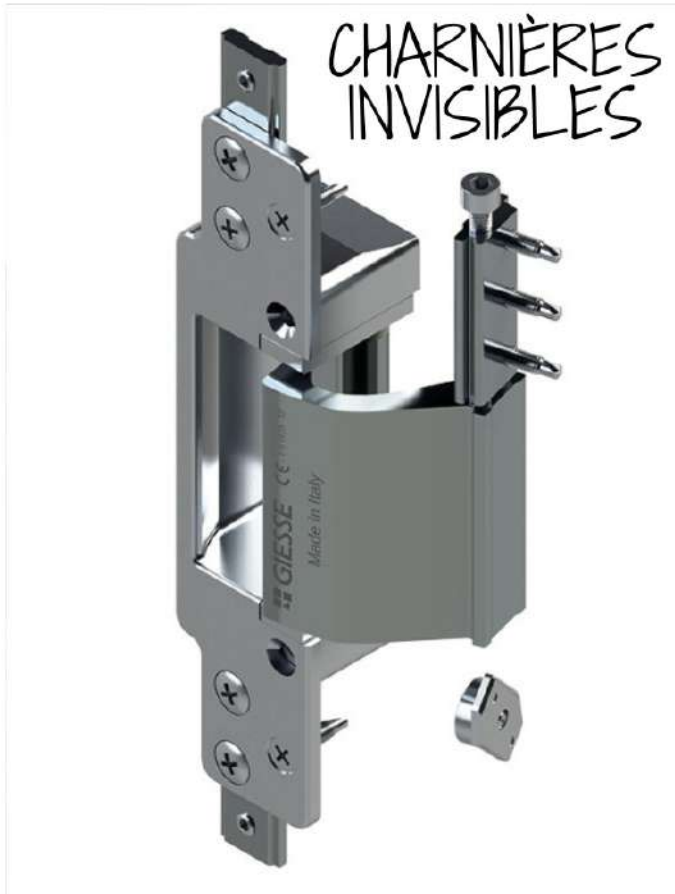

REIMS



REIMS | STEEL DESIGN

Porte monobloc ral 9005 texturé
Déco inox
Porte ouvrant 76mm
Barre de tirage D-05
Serrure 3 ou 5 points winkhaus
Seuil PMR

Options:

- plaxage
- Bicoloration
- Poignée intégrée





ESSENTIELS



REIMS



LAON



DEAUVILLE



ARRAS



EPERNAY

GAMME ESSENTIELS

Porte monobloc, charnières invisible, système anti-dégondage de série



EXCLUSIV DESIGN

Le concept de cette serie est d'ouvrir la finition de votre porte à votre imagination.

Grace à nos machines de dernieres génération d'impression numérique ou digital céramique sur verre, nous pouvons vous proposer tout types de décors afin de faire de votre porte un objet unique, une oeuvre d'art.



MONTRÉAL



VANCOUVER



QUÉBEC



TORINO



TORONTO



FLORENCIA







A ACCESSOIRES





Always precise **WINKHAUS**

SERRURE



ALUPRO À FAIT LE CHOIX DE WINKHAUS RECONNU POUR SA FIABILITÉ ET COMPÉTENCE EN MATIÈRE DE SÉCURITÉ.

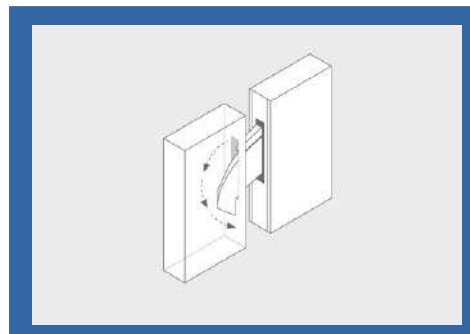



Always precise **WINK HAUS**

HOOKLOCK M :

Quelle plénitude de savoir que la porte est quand-même sécurisée lorsque l'on a oublié de la fermer à clé. Le verrouillage multipoints manuel hooklock m pardonne la négligence de l'utilisateur lorsqu'il oublie de verrouiller car, comme son nom l'indique, verrouille automatiquement. L Fermer la porte. C'est tout !

Hooklock M de Winkhaus est un système de verrouillage multipoints équipé de verrous crochets indépendants entre eux pour un griffage arrière impeccable et d'éléments d'étanchéité pour une compression dynamique.

Dès que l'on ferme la porte, un dispositif magnétique situé sur le dormant déclenche l'actionnement des éléments d'étanchéité et des verrous crochets massifs pour que la porte soit sécurisée contre les accès indésirables. Ils basculent automatiquement. La porte est ainsi toujours bien verrouillée et solidaire du dormant sans verrouillage supplémentaire.

Les verrous à crochets massifs, les éléments d'étanchéité et le pêne peuvent être déverrouillés manuellement par l'intermédiaire du cylindre de fermeture ou de la béquille.



POIGNÉES STANDARD

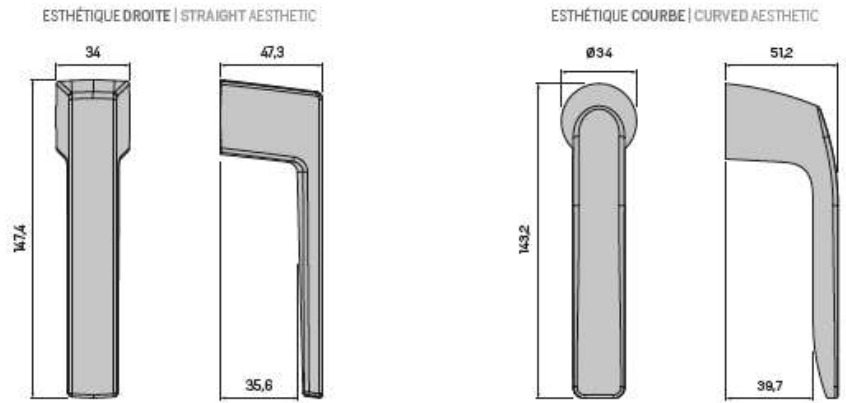

BARRES DE TIRAGE STANDARD

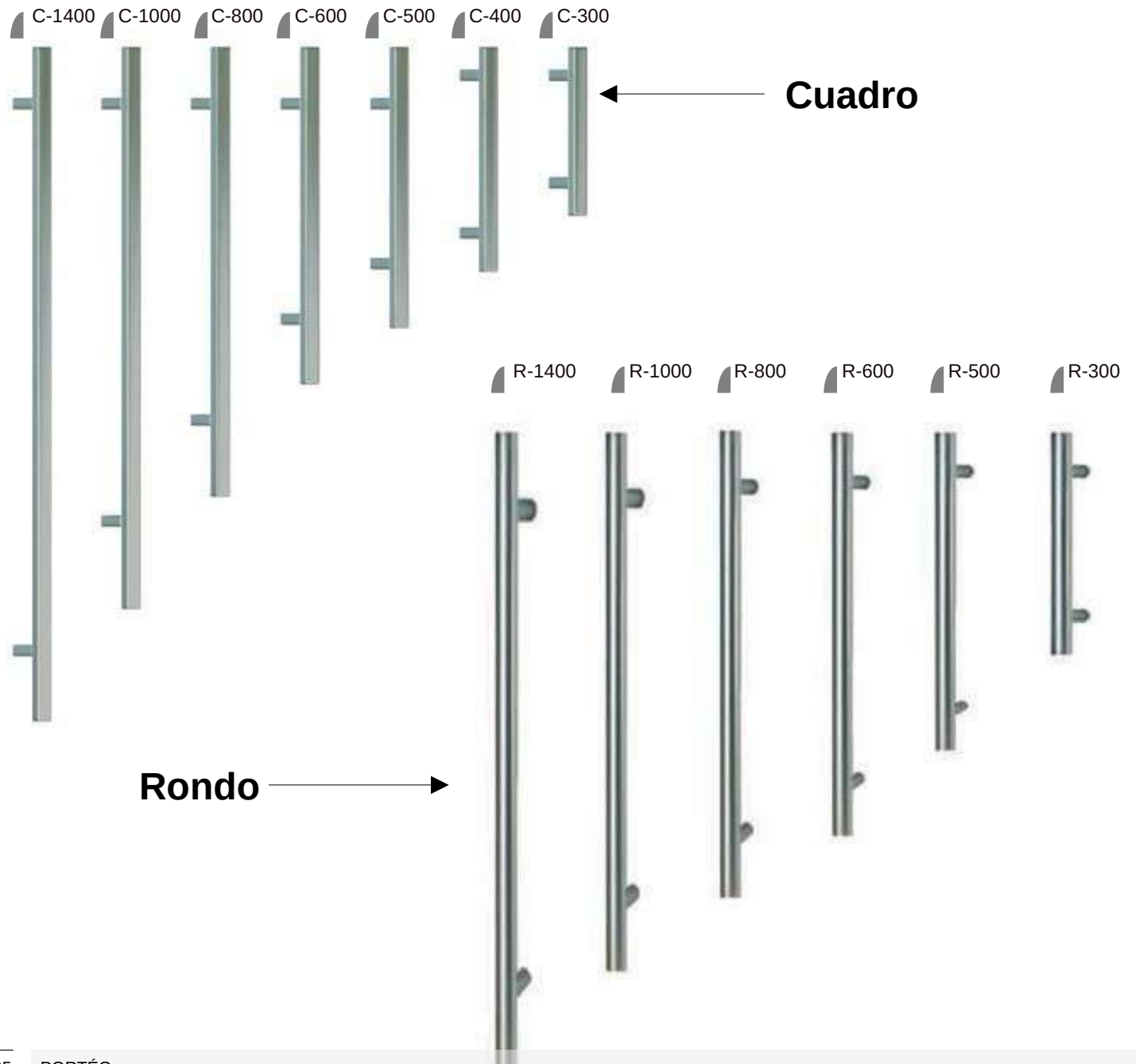

440MM



DÉCO 1

505MM



DÉCO 2

300MM



DÉCO 3

670MM



DÉCO 4

870MM

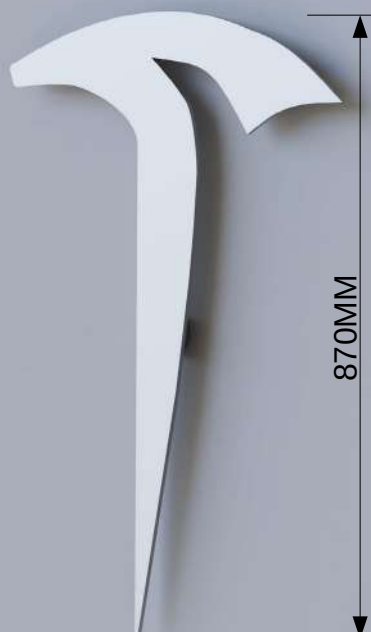

DÉCO 5

870MM



DÉCO 6

650MM



DÉCO 7

400MM



DÉCO 8

550MM



DÉCO 9

500MM

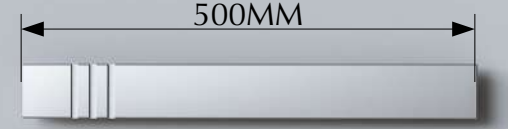

DÉCO 10

EXCLUSIV

BARRE DE TIRAGE

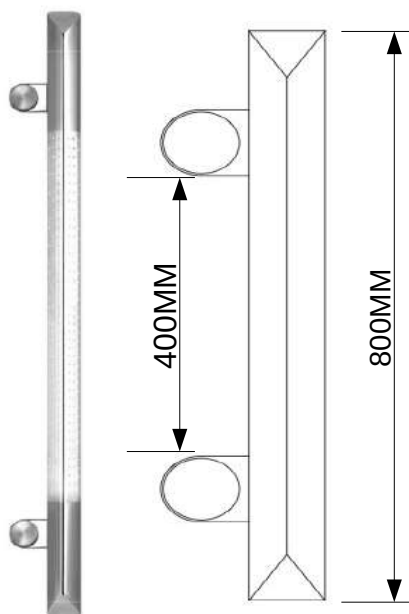

Eclusiv 1

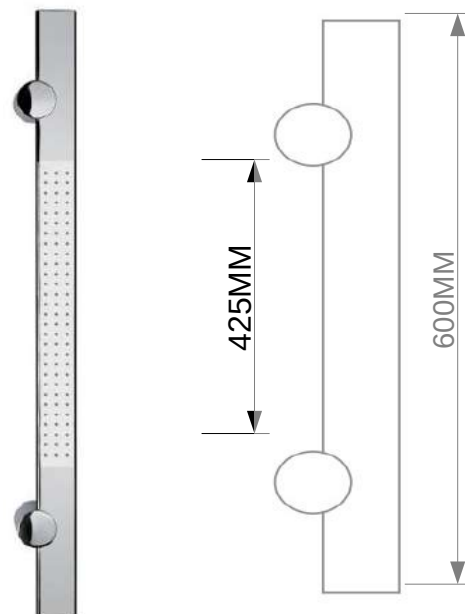

Eclusiv 2



Eclusiv 3

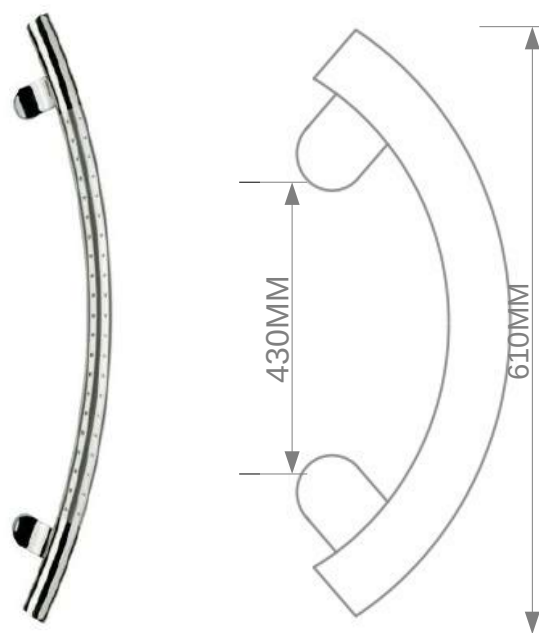

Eclusiv 4

EXCLUSIV 5

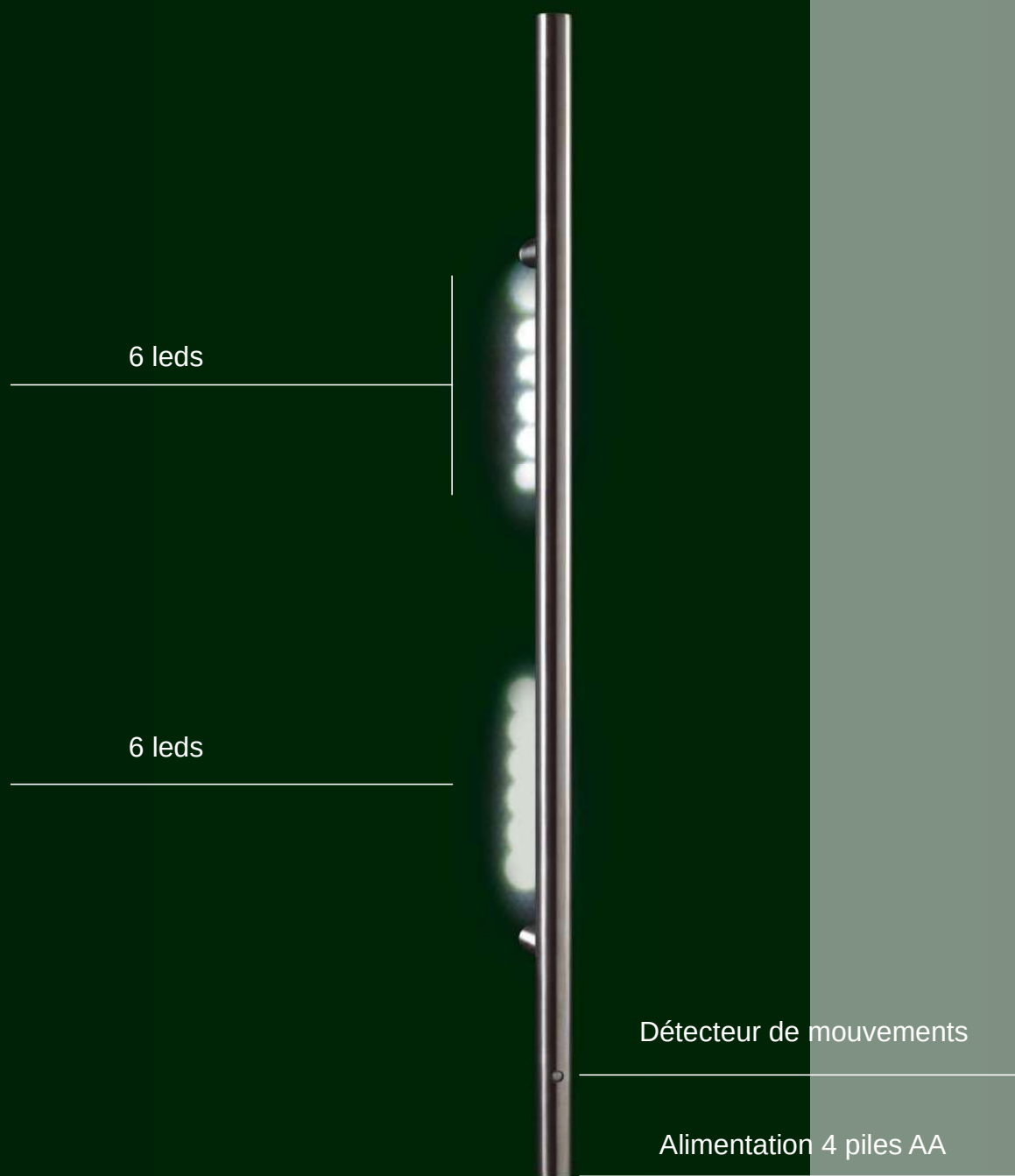

Dimensions :

1800 mm

INVISIBLE vertical

BARRE DE TIRAGE VERTICALE INTÉGRÉE

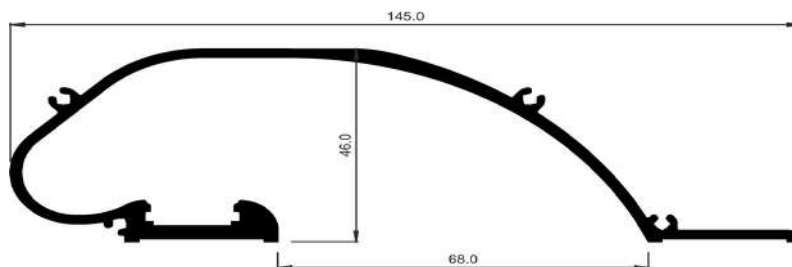

INVISIBLE horizontal

BARRE DE TIRAGE VERTICALE INTÉGRÉE

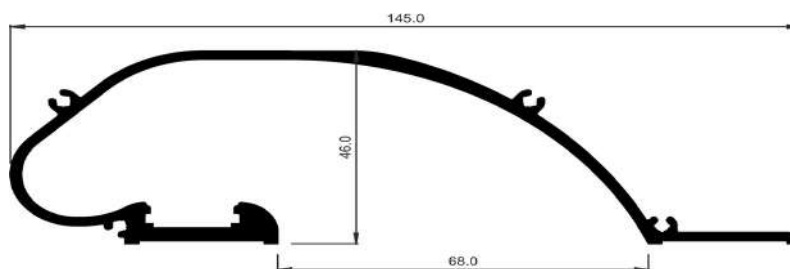

INVISIBLE



Barre de tirage minimaliste intégrée dans la porte, possibilité de placer cet élément sur toutes les portes. Horizontale ou verticale, avec leds ou sans, laissez libre cours à votre Imagination.

Dimensions :
1800 mm
1200 mm
500 mm



Grille 1



Grille 2



Grille 3



Grille 4



Grille 5



Grille 6



Grille fer forgé



Vitrail plomb 1



Vitrail plomb 2



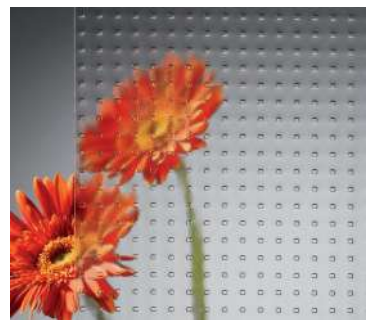
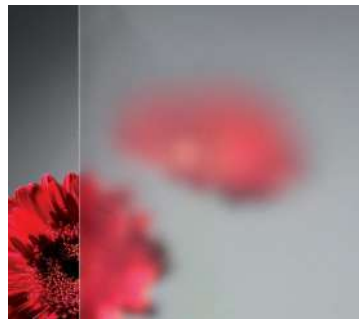
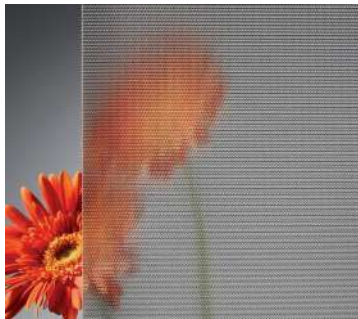



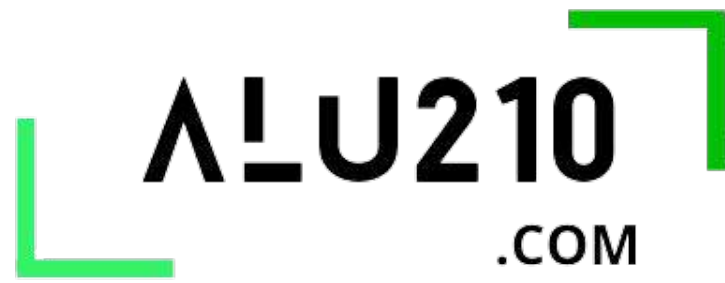

ALU210
.COM