

PORTAILS

PORTAILS - PORTILLONS - CLOTURES

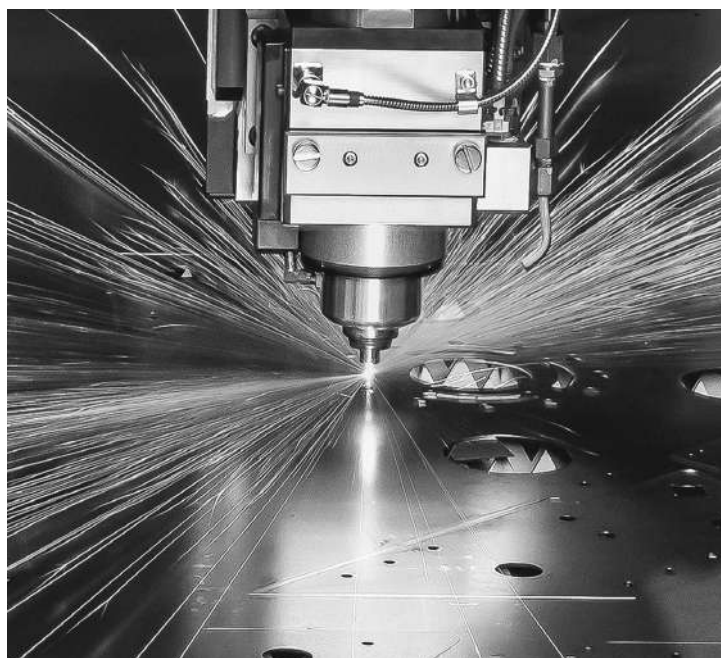

ALU210
.COM

Quand votre maison devient une Oeuvre d'art.

2024

6 – 10

11 – 16

17 – 22

23 – 27

28 – 32

33 – 39

40 – 42

43 – 48

49 – 58

INDICE

DÉCOLINE, LE PORTAIL DÉCO ALUNOX

PERFOLINE ,LE PORTAIL DÉCO PERFORÉ

CRÉALINE, LE PORTAIL DÉCO PLEXI

GLASSLINE ,LE PORTAIL DÉCO VERRE

ÉGÉO , LE PORTAIL DÉCO AJOURÉ

TERRANÉO , LE PORTAIL DÉCO SEMI-AJOURÉ

STRPLINE , LE PORTAIL DESIGN

LES COULEURS

LES ACCESSOIRES



ALU210, une écoute à toutes vos envies !

Après 20 ans d'expérience, les collections de panneaux d'ALUPRO reflètent innovation et savoir-faire

➤ Des produits **100%** sur-mesure !

Nos produits sont fabriqués dans notre usine située en Espagne.
Tout est travaillé, transformé, façonné, pour donner vie à des collections variées.
Modernisation des moyens de production, produits innovants et performants, des outils d'aide à la vente (tarifs , catalogues, outils d'aide à la vente , rool-up, drapeau, comptoir..).

➤ Des outils **de dernière génération CNC**

ALU21 possède aujourd'hui des équipements de production de dernières générations, une équipe qualifiée qui permet une gestion des délais performante .

➤ Une équipe **pour vous satisfaire**

Chez **ALU210**, on cultive l'amour du travail bien fait et la synergie des compétences.
Le professionnalisme est plus que jamais d'actualité et se décline dans tous les métiers de l'entreprise. Qu'il s'agisse de concevoir, fabriquer, mobiliser les équipes, **ALU210** met tous les moyens en œuvre pour vous proposer des produits à la hauteur de vos exigences.

DÉCOLINE



DÉCOLINE



Description Portail DÉCOLINE

C'est un design très attrayant que nous offre la gamme DÉCOLINE. Celle-ci est pourvue en effet d'une rayure horizontale dotée d'un motif ondulé, qui fait son effet sur la façade d'une maison moderne ou plus traditionnelle. Qui plus est, le choix de son coloris vous appartient : trois coloris en série sont proposés, qui sont le noir, le blanc et le gris, mais nous vous proposons également de nous envoyer le RAL de votre choix.

Garantie Qualicoat : vous n'aurez ainsi qu'un entretien moindre à réaliser concernant votre futur portail.

Vous pourrez également choisir les dimensions sur-mesure pour vous, ainsi que le sens d'ouverture, à droite ou à gauche en fonction de la configuration de votre logement.

Sachez également que votre portail sera réalisé avec un aluminium extrudé d'une épaisseur de 3 mm, vous garantissant une excellente robustesse, il est ainsi paré contre les risques de déformations qui pourraient survenir au fil du temps.

- ✓ Portail 100% ALUMINIUM traitement qualitatif: Thermolaquage.
- ✓ Certifié Qualicoat Garantie 10 ans.
- ✓ Assemblage tenons-mortaises usinages sur banc automatique robotisé.
- ✓ Montant aluminium: Largeur:85 mm|Profondeur:48 mm |Epaisseur cloisons:3 mm
- ✓ Lames de remplissage:Hauteur 240 mmX Profondeur25 mm x Epaisseur 3 mm.
- ✓ Avec 2 contre cloisons (lame la plus robuste du marché)
- ✓ Traverse haute Profondeur: 110 mm | Hauteur: 90 mm | Epaisseur 3 mm avec guide intégré en extrusion.
- ✓ Traverse basse renforcée de serie solidairement en extrusion pour fixation de crémaillère.
- ✓ Décoration Alunox sur mesure intérieur et extérieur.

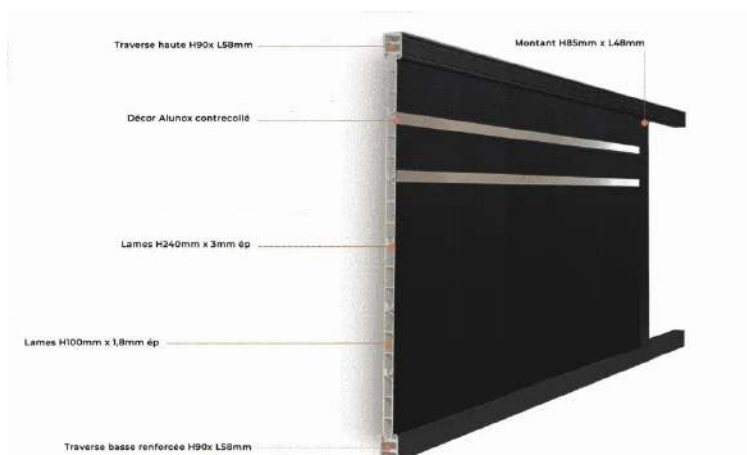



AGÈ | DÉCOLINE

PortAIL coulissant / battant / portillon / cloture

Déco alunox

Motorisation King Gate en option

Couleurs standard:

- Blanc 9016 sablé
- Gris 7016 sablé
- Noir 9005 sablé

Options:

- Plaxage
- Poignée déco
- Poignée intégrée

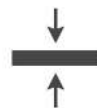

EPAISSEUR DE FEUILLE ALU 3,8MM



DÉCO ALUNOX



DÉCOLINE



AGDE



ARLES



FRÉJUS



HYÈRES



MONACO



NARBONNE



SÈTE



DÉCOLINE



ALBI



ARGELES



BARCARES



BEZIERS



CARCASSONNE



FRONTIGNAN



LEZIGAN



MARSEILLAN



MAZAMET



PERPIGNAN



DÉCOLINE



AGEN



AUCH

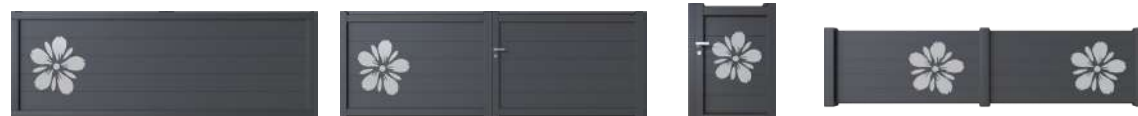

BAYONNE

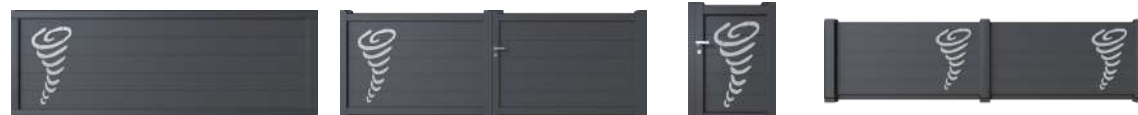

BERGERAC



BIARRITZ

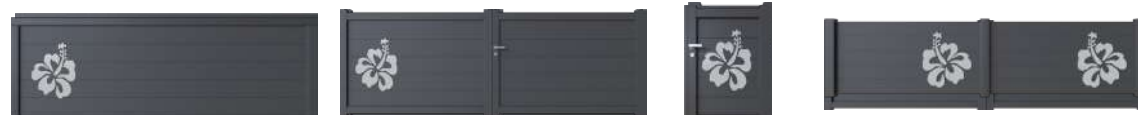

DAX

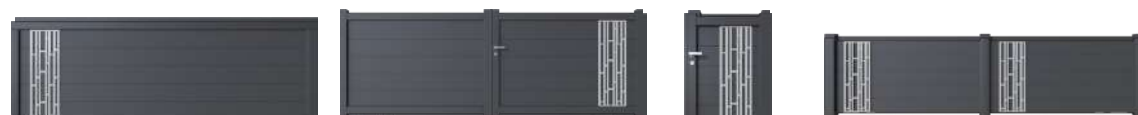

EAUZE



LESCAR



MIOS



MOISSAC



1



2



3



Avec la gamme DÉCOLINE laissez libre court à votre créativité et créez votre portail:

- Envoyez votre idée de découpe alunox.
- Le département de design établit un prototype 3D.
- Il ne vous reste plus qu'à valider et vous obtiendrez votre portail personnalisé.

ALU210
.COM

PERFOLINE



PERFOLINE



Description Portail PERFOLINE

La gamme PERFOLINE est parmi les produits les plus appréciés par notre clientèle de par son motif ajouré géométrique, que vous ne trouverez chez aucun autre. Hormis nos 3 couleurs de série (noir, blanc et gris anthracite), il faut savoir que toutes les coloris sont envisageables : fournissez-nous simplement le RAL de votre choix. Que vous soyez ou non en milieu salin, le thermolaquage Qualicoat résiste aux éléments et au temps. Ce portail battant bénéficie d'une garantie de 10 ans et de la norme ISO 9001. Étant un modèle semi-ajouré, il peut convenir à toutes les façades. L'aluminium extrudé composant ce produit rigidifie la structure de ce modèle, qui se compose de lames de 240mm de hauteur et sections de lames de 3mm d'épaisseur. Nous concevons votre portail battant sur-mesure, en fonction de vos dimensions. Qualité, esthétique et petit prix sont les maîtres mots chez ALU210 !

- ✓ Portail 100% ALUMINIUM traitement qualitatif: Thermolaquage.
- ✓ Certifié Qualicoat Garantie 10 ans.
- ✓ Assemblage tenons-mortaises usinages sur banc automatique robotisé.
- ✓ Montant aluminium: Largeur: 85 mm | Profondeur: 48 mm | Epaisseur cloisons 3mm
- ✓ Traverses aluminium: 90 mm x 58 mm.
- ✓ Epaisseur cloisons 3mm.
- ✓ Panneau de remplissage déco perforé: tôle aluminium ajourée de 3mm d'épaisseur parclosée en périphérique.
- ✓ Aucune visse ni soudure pour conserver l'esthétique.
- ✓ Traverse haute Profondeur: 110mm | Hauteur: 90mm | Epaisseur: 3mm avec guide intégré en extrusion.

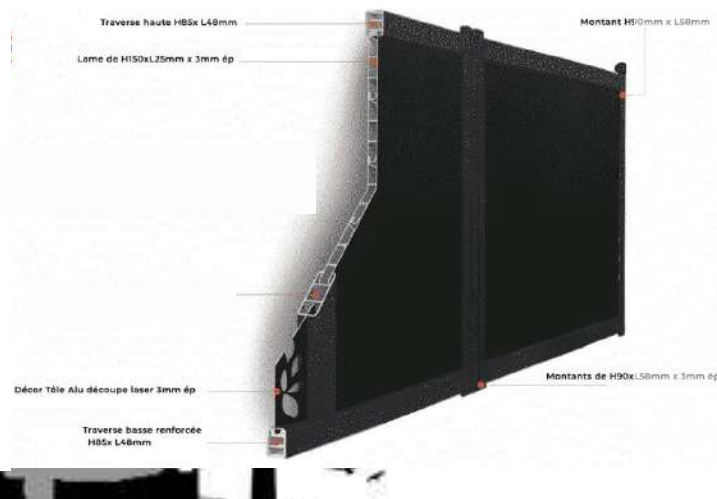

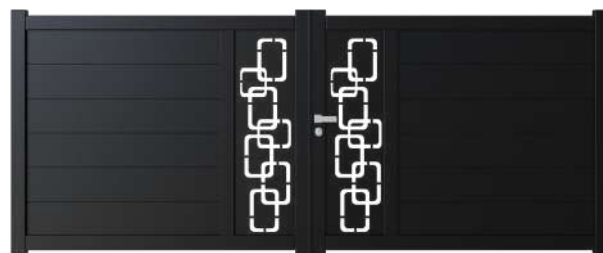

SAINTES | PERFOLINE

PortAIL coulissant / battant / portillon / cloture

Déco alunox

Motorisation King Gate en option

Couleurs standard:

- Blanc 9016 sablé
- Gris 7016 sablé
- Noir 9005 sablé

Options:

- Plaxage
- Poignée déco
- Poignée intégrée

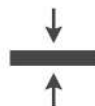

EPAISSEUR DE FEUILLE ALU 3,8MM

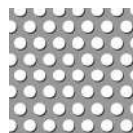

TOLE PERFORÉE





HONFLEUR | PERFOLINE

PortAIL coulissant / battant / portillon / cloture

Déco alunox

Motorisation King Gate en option

Couleurs standard:

- Blanc 9016 sablé
- Gris 7016 sablé
- Noir 9005 sablé

Options:

- Plaxage
- Poignée déco
- Poignée intégrée

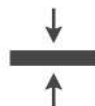

EPAISSEUR DE FEUILLE ALU 3,8MM

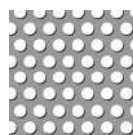

TOLE PERFORÉE



PERFOLINE



RENNES



LORIENT



VANNES

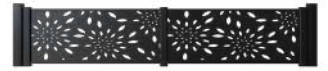

ROYAN



SAINTE



HONFLEUR





CRÉALINE



Le pouvoir de créer...



EXCELLENCE TECHNIQUE ET INNOVATION CRÉATIVE

➤ Intégration d'outils de dernière génération !

Alu210 Industrie vient d'intégrer plusieurs outils afin de proposer toujours plus de nouveautés, plus de design. Grâce aux imprimantes grand format laissez libre court à votre imagination et faites de votre portail un objet de Décoration.

➤ Multipliez les textures !

Portails avec décoration aspect pierres, marbre. Métal, bois faites de votre création un produit unique.

➤ Envoyez nous vos Designs !

Alupro s'adapte à votre demande et vous laisse la possibilité de nous faire parvenir vos idées et nous ferons en sorte de répondre à votre demande.





STRASBOURG | CRÉALINE

PortAIL coulissant / battant / portillon / cloture

Déco alunox

Motorisation King Gate en option

Couleurs standard:

- Blanc 9016 sablé
- Gris 7016 sablé
- Noir 9005 sablé

Options:

- Plaxage
- Poignée déco
- Poignée intégrée

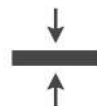

EPAISSEUR DE FEUILLE ALU 3,8MM



IMPRESSION NUMÉRIQUE ANTI UV



MONTÉLIMAR | CRÉALINE

PortAIL coulissant / battant / portillon / cloture

Déco impression numérique

Motorisation King Gate en option

Couleurs standard:

- Blanc 9016 sablé
- Gris 7016 sablé
- Noir 9005 sablé

Options:

- Plaxage
- Poignée déco
- Poignée intégrée

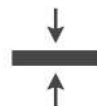

EPAISSEUR DE FEUILLE ALU 3,8MM



IMPRESSION NUMÉRIQUE ANTI UV

CRÉALINE



STRASBOURG



COLMAR



BESANÇON



METZ



DIJON



LYON



VIENNE



VALENCE





GLASSLINE

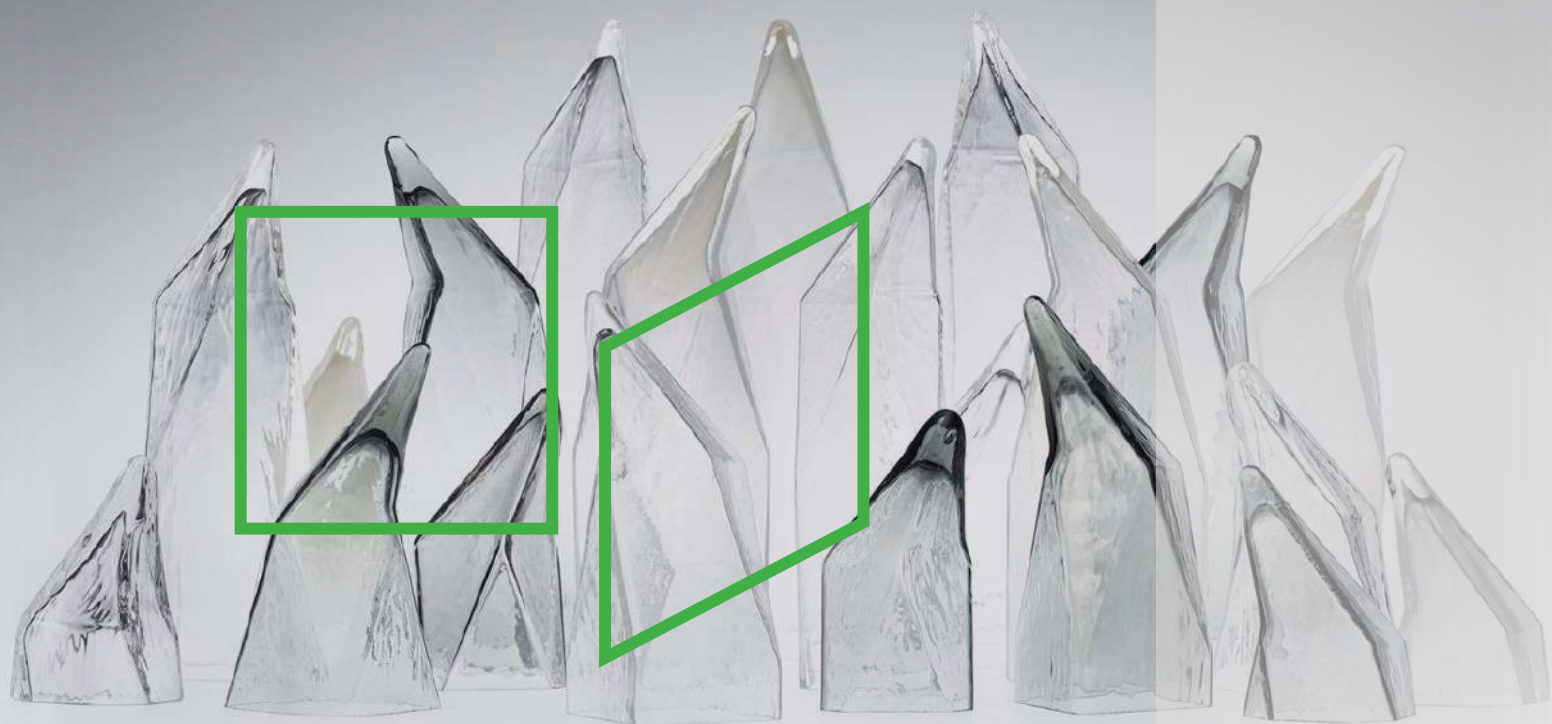

L'art verrier ...



➤ Intégration d'outils de dernière génération !

Alu210 vient d'intégrer plusieurs outils afin de proposer toujours plus de nouveautés, plus de design. Grace aux imprimantes grand format laissez libre court à votre imagination et faite de votre portail un objet de Décoration.

➤ Impression sur vitrage de sécurité !

Portails avec décoration aspect pierres, marbre. Métal, bois faites de votre création un produit unique.

➤ Envoyez nous vos idées !

Alu210 s'adapte à votre demande et vous laisse la possibilité de nous faire parvenir vos idées et nous ferons en sorte de répondre à votre demande.



GLASSLINE



AGEN



BAYONNE



BIARRITZ



BORDEAUX



DAX



PAU



TARBES





TARBES | GLASSLINE

PortAIL coulissant / battant / portillon / cloture

Déco VERRE TREMPÉ

Motorisation King Gate en option

Couleurs standard:

- Blanc 9016 sablé
- Gris 7016 sablé
- Noir 9005 sablé

Options:

- Plaxage
- Poignée déco
- Poignée intégrée

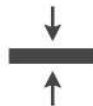

EPAISSEUR DE FEUILLE ALU 3,8MM



IMPRESSION NUMÉRIQUE ANTI UV

COMPOSITION VITRAGE DÉCO 44.2-10-44.2



AGÈN | GLASSLINE

PortAIL coulissant / battant / portillon / cloture

Déco VERRE TREMPÉ

Motorisation King Gate en option

Couleurs standard:

- Blanc 9016 sablé
- Gris 7016 sablé
- Noir 9005 sablé

Options:

- Plaxage
- Poignée déco
- Poignée intégrée

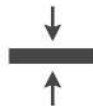

EPAISSEUR DE FEUILLE ALU 3,8MM



IMPRESSIION NUMÉRIQUE ANTI UV

COMPOSITION VITRAGE DÉCO 44.2-10-44.2

ÉΓΕΟ

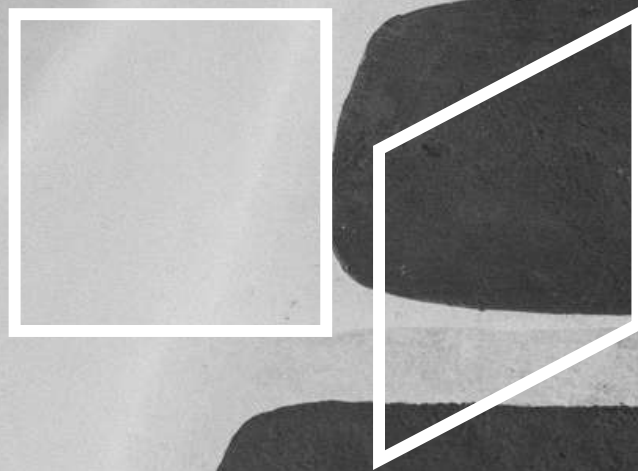

ÉGÉO



Description Portail ÉGÉO

Si ce portail ÉGÉO fait partie des produits les plus souvent demandés, c'est sans le moindre doute pour leurs motifs ajourés. Il s'agit d'une gamme qui habillera élégamment votre façade. Ce portail bénéficie d'une garantie de 10 ans et de la norme ISO 9001. Nous thermolaquons votre portail coulissant selon vos inspirations : trois références sont proposées de série (anthracite, noir, blanc), mais nous avons la possibilité de personnaliser totalement la couleur. La peinture est réalisée par thermolaquage, et dispose du label Qualicoat : sa couleur ne s'affadit pas, et ne s'écaille pas au fil du temps. C'est également le cas en milieu salin. Bien sûr, ce portail coulissant se fabrique sur-mesure, selon vos dimensions. En matière de structure, ce produit dispose de découpes laser sur tôle aluminium perforée de 3mm d'épaisseur, un soin tout particulier est apporté à la fabrication et il s'agit d'un modèle en 100% aluminium extrudé, afin d'éviter tout gondolage éventuel année après année. Petits prix et qualité irréprochable sont font de ALUPRO un acteur clé du marché !

- ✓ Portail 100% ALUMINIUM traitement qualitatif: Thermolaquage.
- ✓ Certifié Qualicoat Garantie 10 ans.
- ✓ Assemblage tenons-mortaises usinages sur banc automatique.
- ✓ Montant aluminium: Largeur: 85 mm | Profondeur: 48 mm | Epaisseur cloisons 3mm
- ✓ Traverse haute Profondeur: 110 mm | Hauteur: 90 mm | Epaisseur: 3 mm avec guide intégré en extrusion.
- ✓ Traverse basse renforcée 90mm x 58 mm de serie solidairement en extrusion pour fixation de crémaillère.

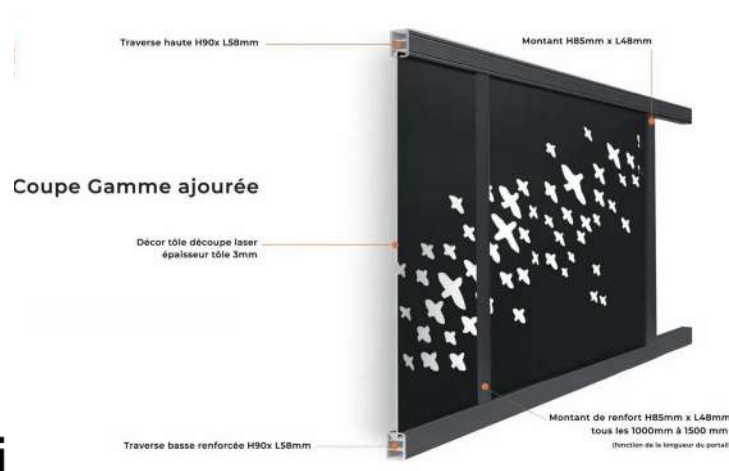



NAXOS | ÉGÉO

PortAIL coulissant / battant / portillon / cloture

Déco alunox

Motorisation King Gate en option

Couleurs standard:

- Blanc 9016 sablé
- Gris 7016 sablé
- Noir 9005 sablé

Options:

- Plaxage
- Poignée déco
- Poignée intégrée

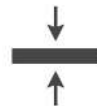

EPAISSEUR DE FEUILLE ALU 3,8MM

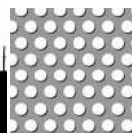

TOLE PERFORÉE



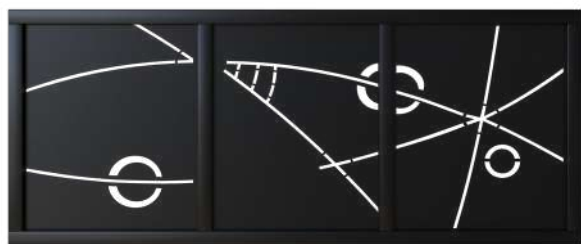

MILOS | ÉGÉO

PortAIL coulissant / battant / portillon / cloture

Déco alunox

Motorisation King Gate en option

Couleurs standard:

- Blanc 9016 sablé
- Gris 7016 sablé
- Noir 9005 sablé

Options:

- Plaxage
- Poignée déco
- Poignée intégrée

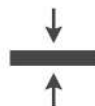

EPAISSEUR DE FEUILLE ALU 3,8MM

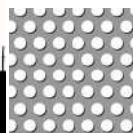

TOLE PERFORÉE



ÉGÉO

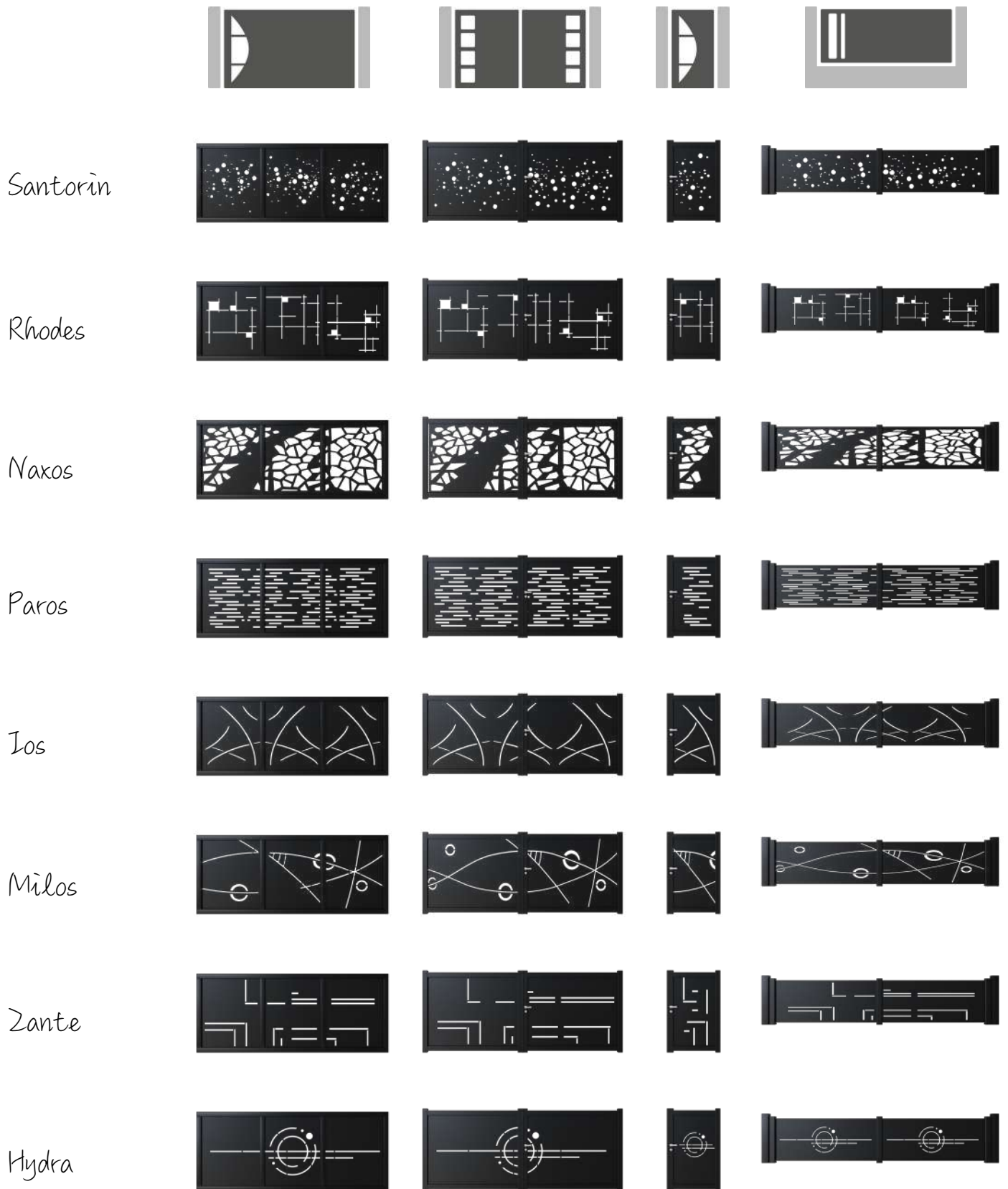

TERRANÉO



TERRANÉO



Description Portail TERRANÉO

La gamme TERRANÉO est parmi les produits les plus appréciés par notre clientèle de par son motif ajouré géométrique, que vous ne trouverez chez aucun autre. Hormis nos 3 couleurs de série (noir, blanc et gris anthracite), il faut savoir que toutes les coloris sont envisageables : fournissez-nous simplement le RAL de votre choix. Que vous soyez ou non en milieu salin, le thermolaquage Qualicoat résiste aux éléments et au temps. Ce portail battant bénéficie d'une garantie de 10 ans et de la norme ISO 9001. Étant un modèle semi-ajouré, il peut convenir à toutes les façades. L'aluminium extrudé composant ce produit rigidifie la structure de ce modèle, qui se compose de lames de 240mm de hauteur et sections de lames de 3mm d'épaisseur. Nous concevons votre portail battant sur-mesure, en fonction de vos dimensions. Qualité, esthétique et petit prix sont les maîtres mots chez ALUPRO !

- ✓ Portail 100% ALUMINIUM traitement qualitatif: Thermolaquage.
- ✓ Certifié Qualicoat Garantie 10 ans.
- ✓ Assemblage tenons-mortaises usinages sur banc automatique robotisé.
- ✓ Montant aluminium: Largeur: 85 mm | Profondeur: 48 mm | Epaisseur cloisons 3mm
- ✓ Traverses aluminium: 90 mm x 58 mm.
- ✓ Epaisseur cloisons 3mm.
- ✓ Panneau de remplissage déco perforé: tôle aluminium ajourée de 3mm d'épaisseur parclosée en périphérique.
- ✓ Aucune visse ni soudure pour conserver l'esthétique.
- ✓ Traverse haute Profondeur: 110mm | Hauteur: 90mm | Epaisseur: 3mm avec guide intégré en extrusion.

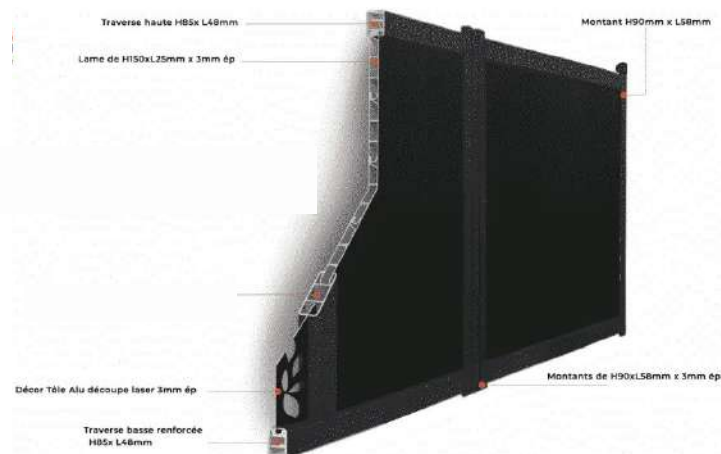

I karia

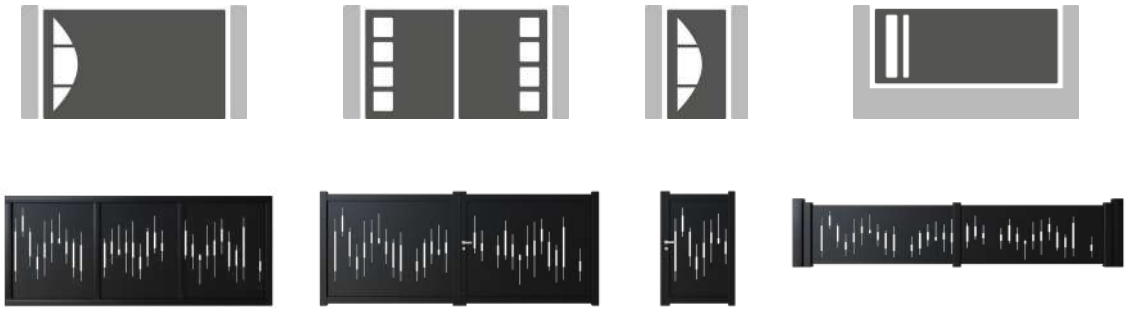

Kos



Amorgos

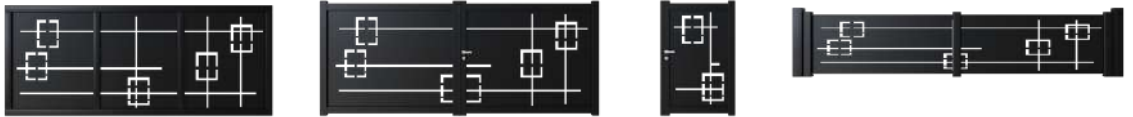

Samos



Patmos



Symì



Sifnos



Anafi



TERRANÉO



Majorque



Ibiza



Menorque



Lanzarote



Palma



Tenerife



Fuerteventura



Gomera



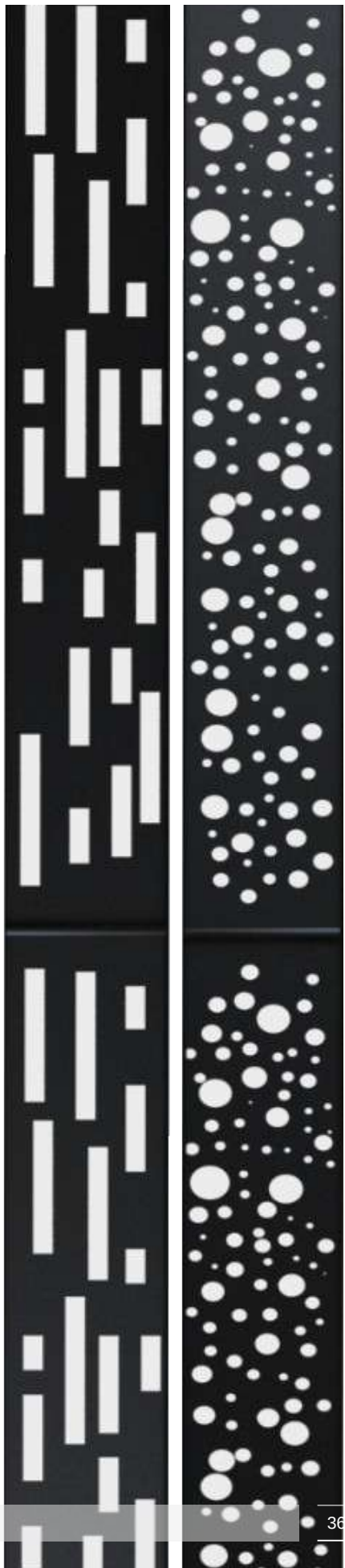
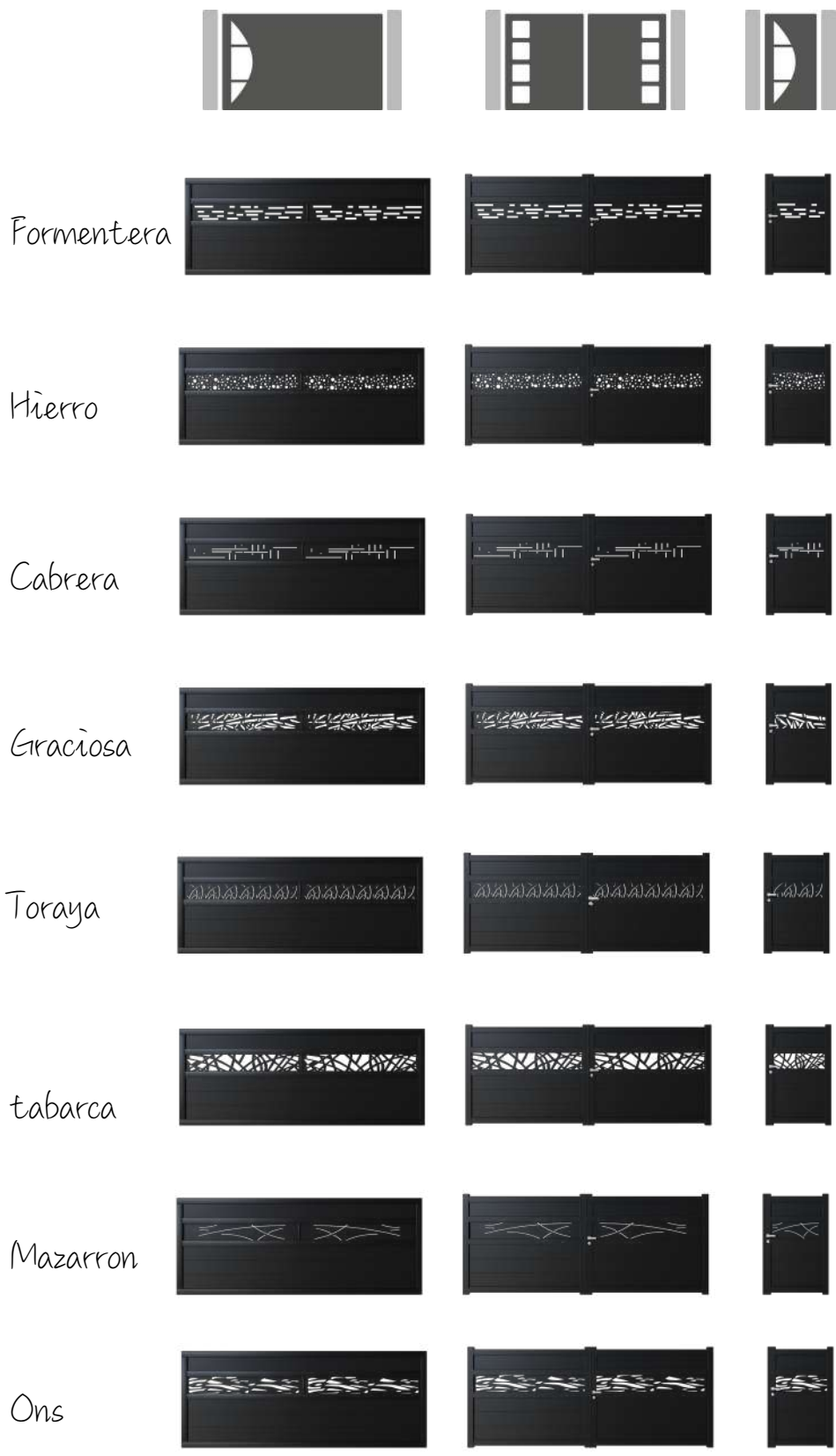

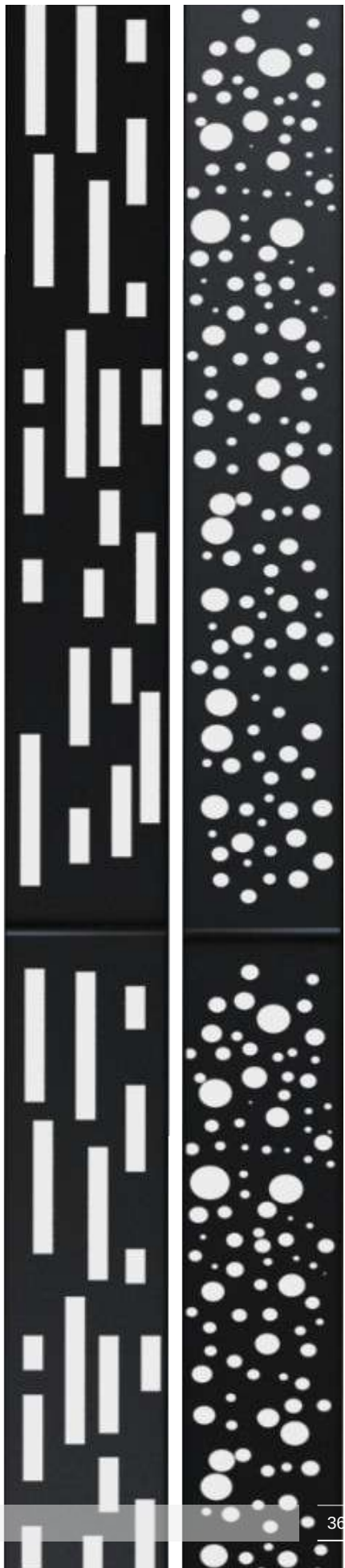
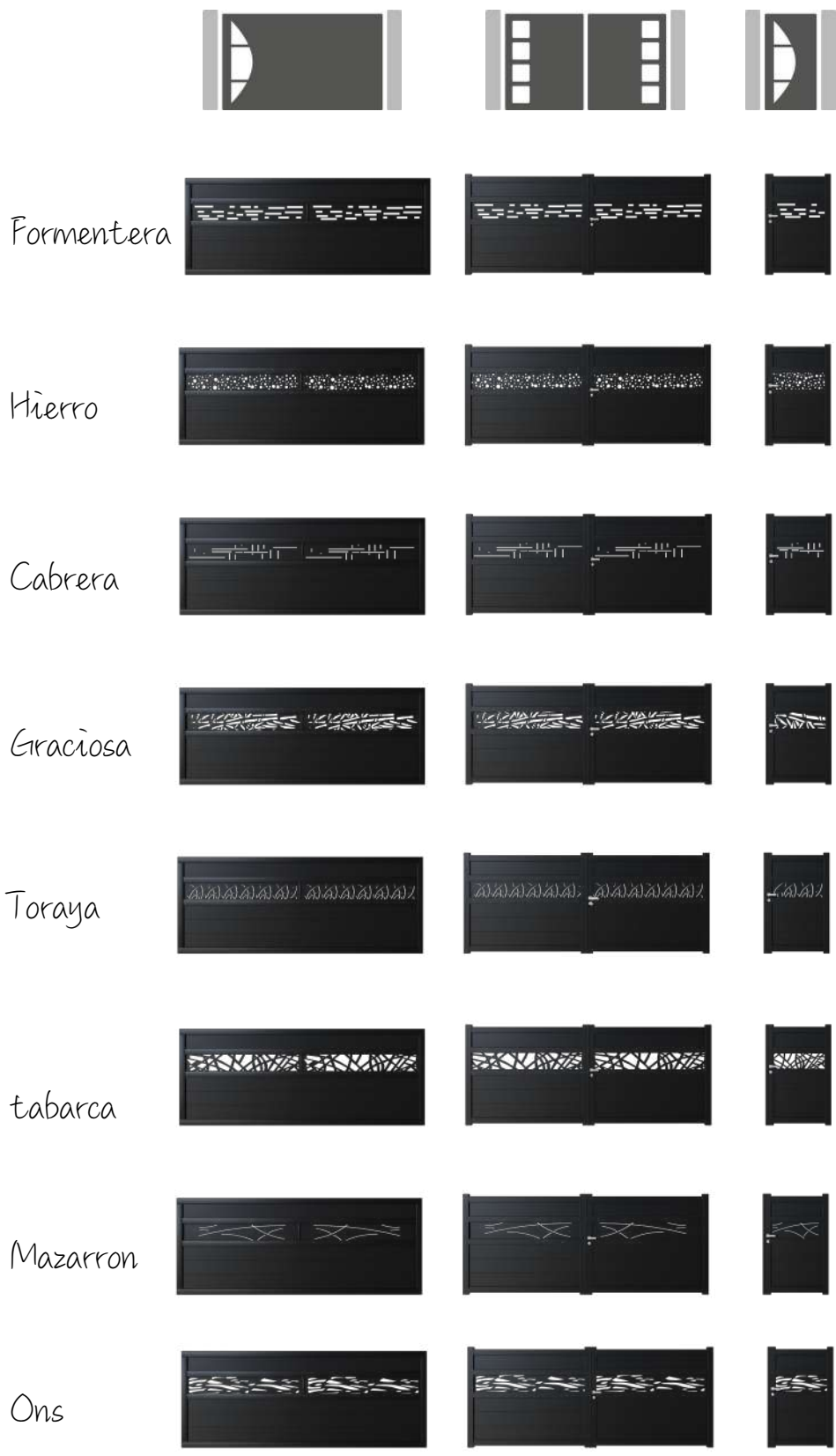

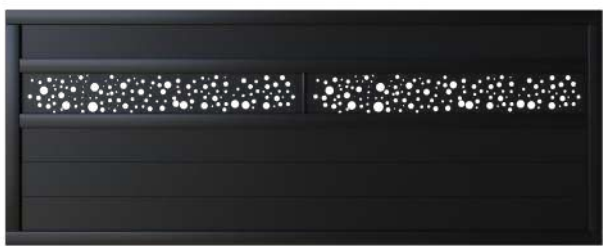

IBIZA | TERRANÉO

PortAIL coulissant / battant / portillon / cloture

Déco alunox

Motorisation King Gate en option

Couleurs standard:

- Blanc 9016 sablé
- Gris 7016 sablé
- Noir 9005 sablé

Options:

- Plaxage
- Poignée déco
- Poignée intégrée

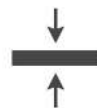

EPAISSEUR DE FEUILLE ALU 3,8MM

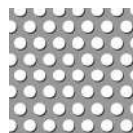

TOLE PERFORÉE



STRIPLINE



Description Portail CARIBÉO



L'unicité de la gamme CARIBÉO réside dans son design minimaliste à lames horizontales, que vous ne trouverez nulle part ailleurs. Ce portail battant dispose d'une garantie de 10 ans et de la norme ISO 9001. Nous créerons votre portail battant sur-mesure. Hormis nos trois couleurs par défaut (blanc, anthracite, noir), nous pouvons proposer la teinte de votre choix. Que vous vous situiez ou non en milieu salin, le thermolaquage Qualicoat permet à votre portail battant de ne pas s'écailler ni s'affadir. Étant un modèle à barreaux, il peut s'associer avec l'ensemble des façades. L'aluminium extrudé qui compose ce portail battant rigidifie la structure de ce modèle, qui est doté de lames de 150mm et 50mm. ALUPRO a pour objectif de vous proposer des produits de haute qualité, au meilleur prix.

- ✓ Portail 100% ALUMINIUM traitement qualitatif: Thermolaquage.
- ✓ Certifié Qualicoat Garantie 10 ans.
- ✓ Assemblage tenons-mortaises usinages sur banc automatique.
- ✓ Montant aluminium: Largeur: 85 mm | Profondeur: 48 mm | Epaisseur cloisons 3mm
- ✓ Traverses aluminium : 90 mm x 58 mm.
- ✓ Combinaison de lames de hauteur: 150 et 50 mm avec une profondeur de 25 mm ainsi qu'une épaisseur de 3 mm.
- ✓ Espace entre les lames : 50 mm ajusté selon dimensions du portail.
- ✓ Traverse adaptée pour fixation de moteur.

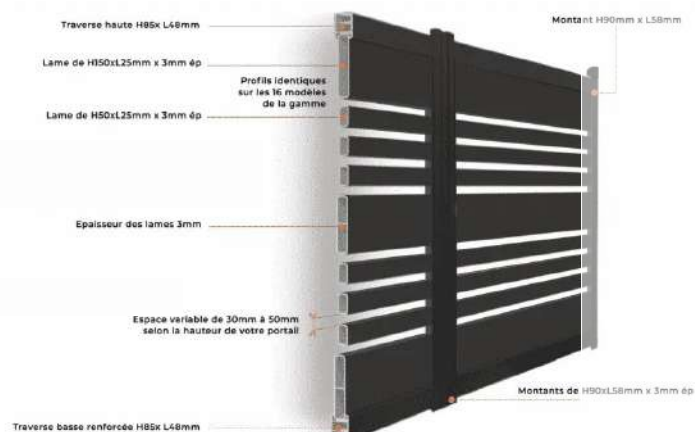

STRIPLINE



Oporto



Coimbra



Aveiro



Lisboa



Setubal



Faro



Evora



Braga



STRIPLINE



Tavira



Lagos



COULEURS



La couleur

“ Nous vous proposons un choix de couleurs ”

Afin d'optimiser son process et de croître en réactivité, **ALU210** travaille avec une unité de laquage dernière génération qui respecte les normes de respect de environnementales , le tout au normes QUALICOAT, QUALIMARINE, et QUALINODE.

Les laquages 2 finitions

Finition **mate** (inférieure à 40 % de brillance)
Finition **satinée** (60 à 70 % de brillance)



Les laquages fines textures

Une large palette de teintes qui offre une meilleure résistance aux risques de rayures.



La couleur !
Choisissez le savoir-faire
ALU21 !



Couleurs Gamme Architecture

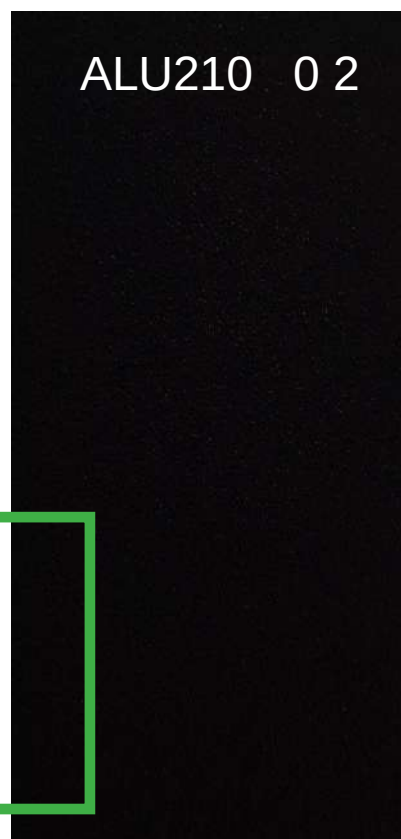
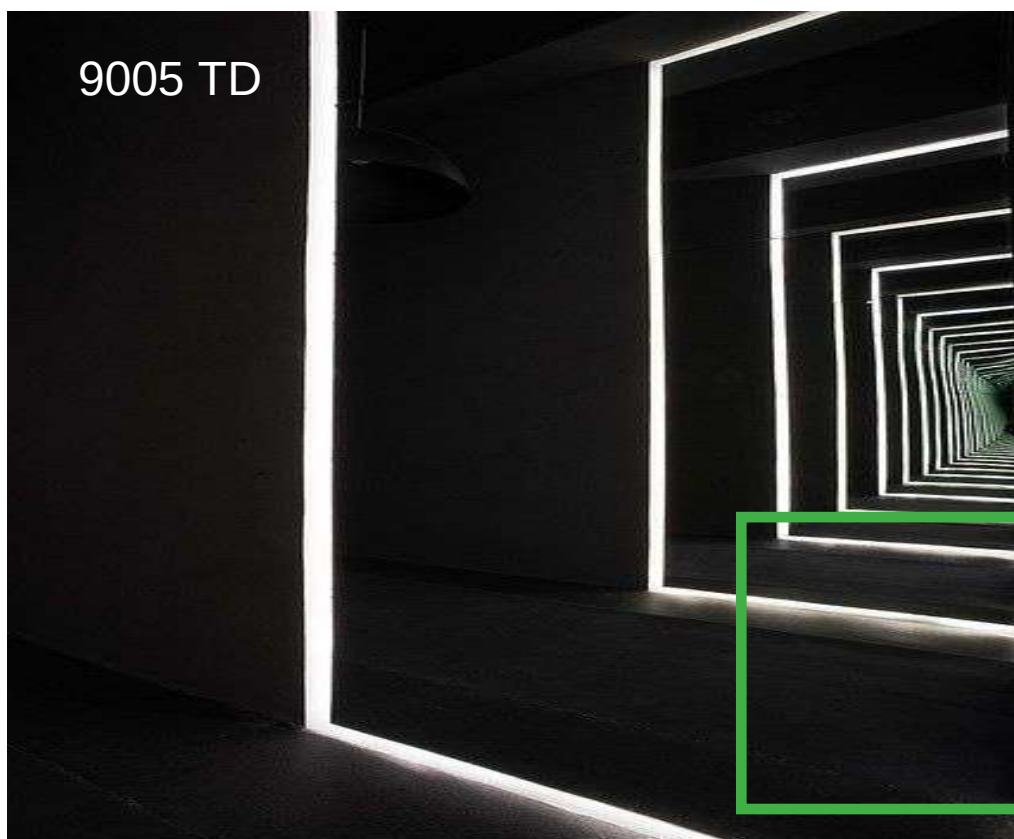

ALU210 0 3

7035 TD

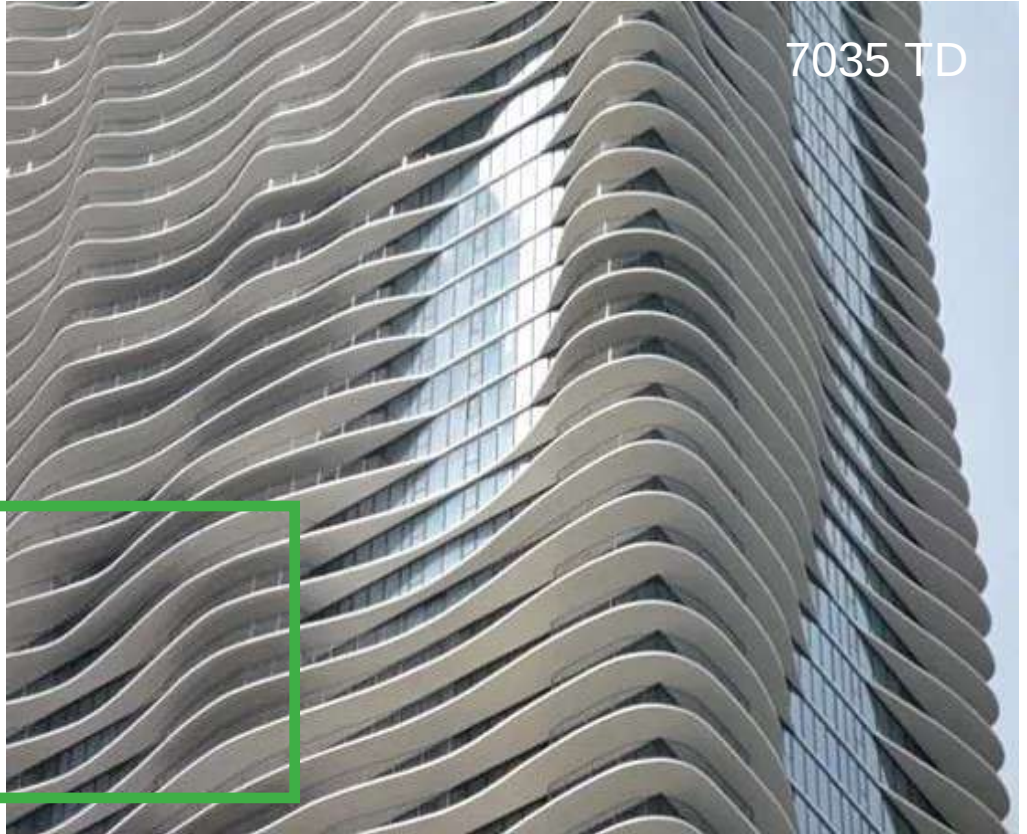

ALU210 0 4

7039 TD

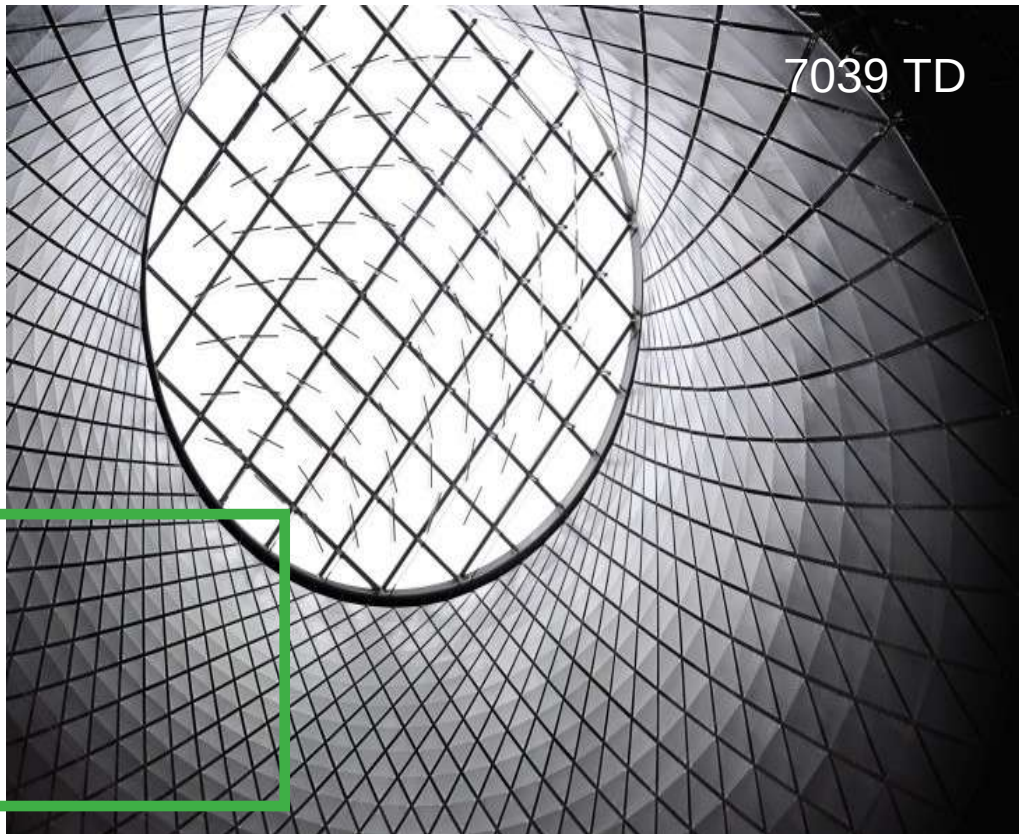

Couleurs Gamme Tendance

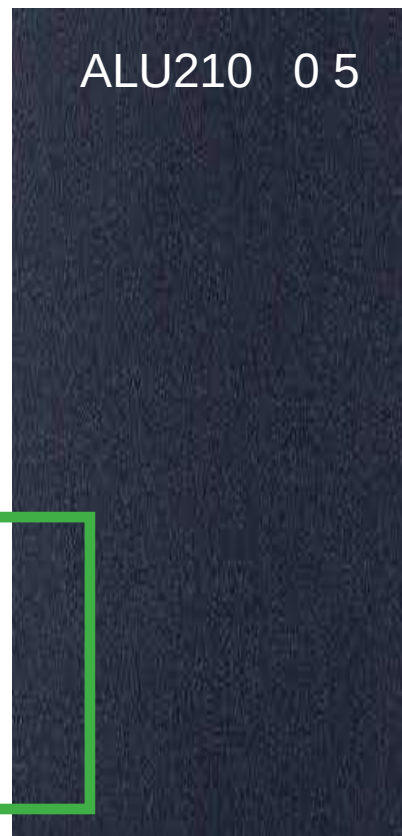

ALU210 07

Gris 2150 Sablé YW365F



ALU210 08

Brun 2650 Sablé YW366F



Accessoires





Accessoires portail battants motorisé, bras de guidage inclus

Pivot haut réglage tri directionnel avec capot de propreté

Crapaudine basse réglable

Sabot de réception

Renforts sur traverse basses

Moteur 2 bras articulés ou vérins

2 photocellules

2 télécommandes

1 feu clignotant et antenne intégrée



Accessoires portail coulissant manuel

Pivot haut réglage tri directionnel avec capot de propreté

Crapaudine basse réglable

Sabot de réception

Poignée gâche et barillet

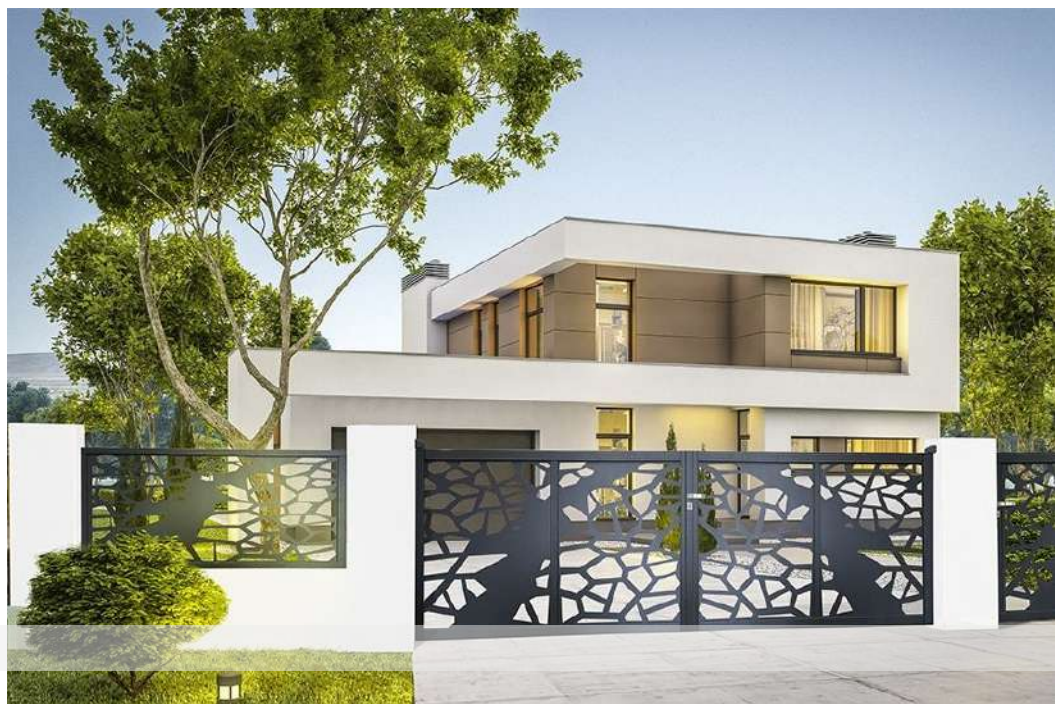

ALU210 EXPERT un automatisme solide et résistant



Automatismes pour **portails coulissants** jusqu'à 600 kg



Accès pratique à la centrale de commande

Électronique Smart Traditional incorporée



Débrayage protégé

Structure en aluminium moulé

DONNÉES TECHNIQUES

EXPERT ALU210 coulissant



MODÈLE EXPERT	600AC
VITESSE	12M/MIN
NUISANCE	<56 DB
RÉSISTANCE TEMPÉRATURE	-20°C / +70 °C
TELECOM DISTANCE	30M
FRÉQUENCE	433,92 MHZ

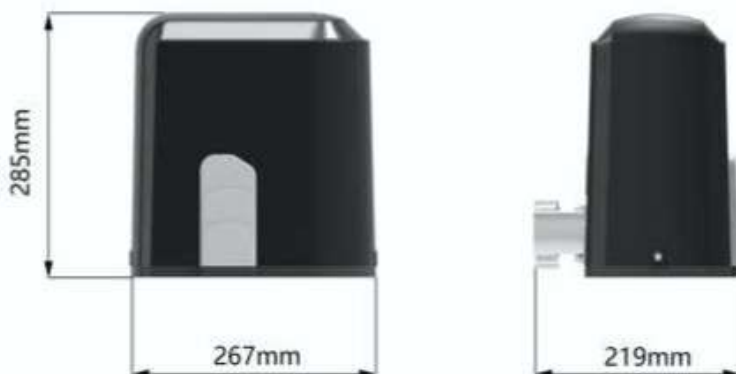

Fonction du produit

1. Démarrage progressif et arrêt lent
2. Inversion automatique après avoir rencontré des obstacles
3. La force de sortie du moteur, la force de décrochage et la distance d'arrêt lent sont réglables
4. Ouverture partielle aux laissez-passer piétons

Nos avantages

EXPERT210 est un moteur qui s'appuie sur de solides capacités techniques et de recherche et développement, un produit de qualité, et un service après-vente efficace.

ALU210 EXPERT **un automatisme solide et résistant**



Automatismes pour **portails battants** jusqu'à 400 kg

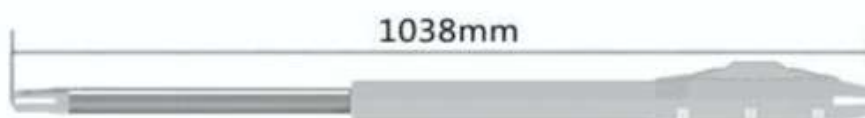
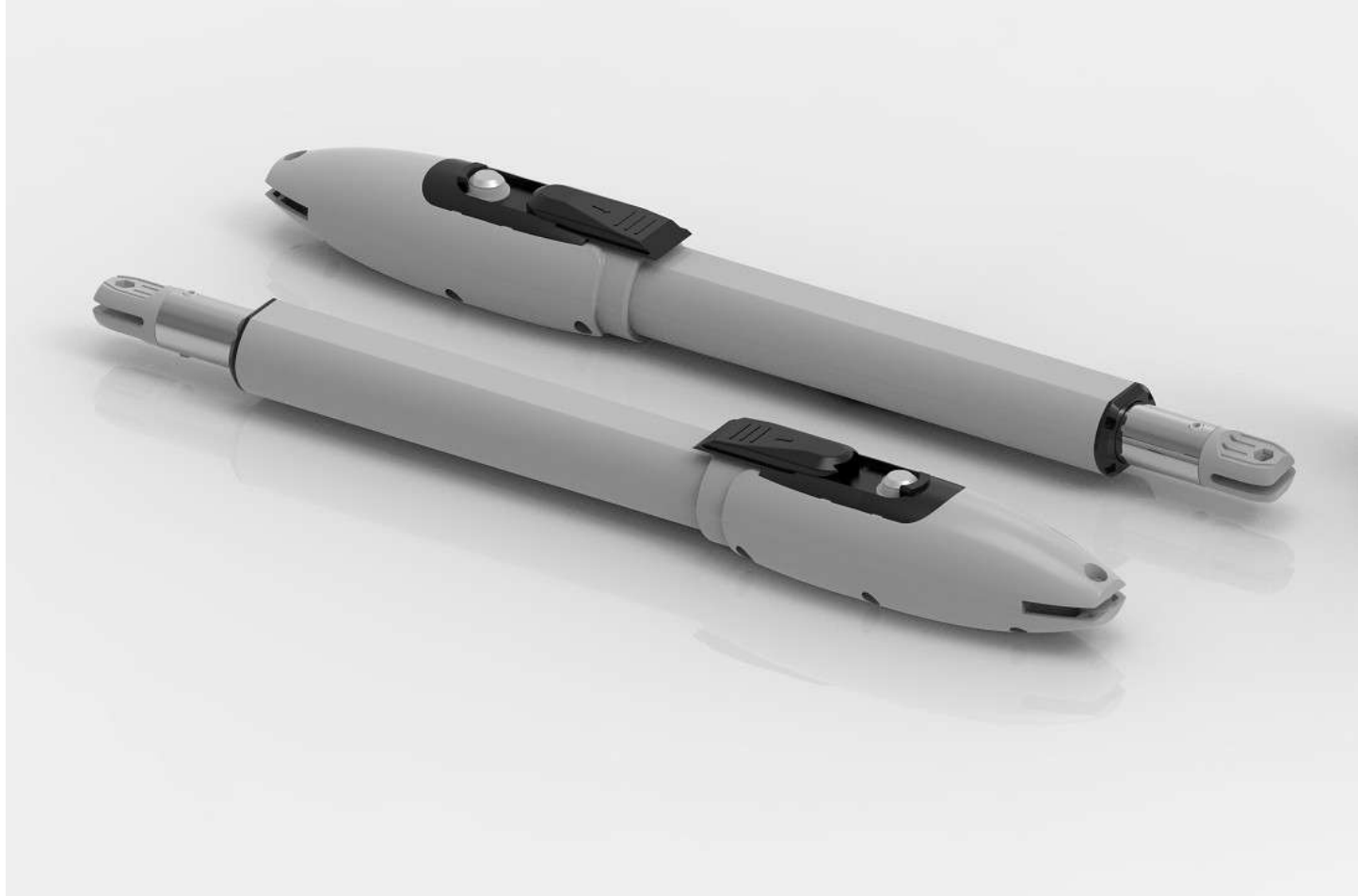

DONNÉES TECHNIQUES

EXPERT ALU210 coulissant



MODÈLE EXPERT	600AC
VITESSE	18/22s/90°
NUISANCE	<58 DB
RÉSISTANCE TEMPÉRATURE	-20°C / +70 °C
TELECOM DISTANCE	30M
FRÉQUENCE	433,92 MHZ



Fonction du produit

1. Démarrage progressif et arrêt lent
2. Inversion automatique après avoir rencontré des obstacles
3. Fermeture automatique ajustable
4. Ouverture partielle aux laissez-passer piétons
5. Possibilité d'ouverture manuelle

Nos avantages

EXPERT210 est un moteur qui s'appuie sur de solides capacités techniques et de recherche et développement, un produit de qualité, et un service après-vente efficace.

Dynamos un automatisme solide et résistant aux agents atmosphériques.



Automatismes pour **portails coulissants** jusqu'à 1000 kg

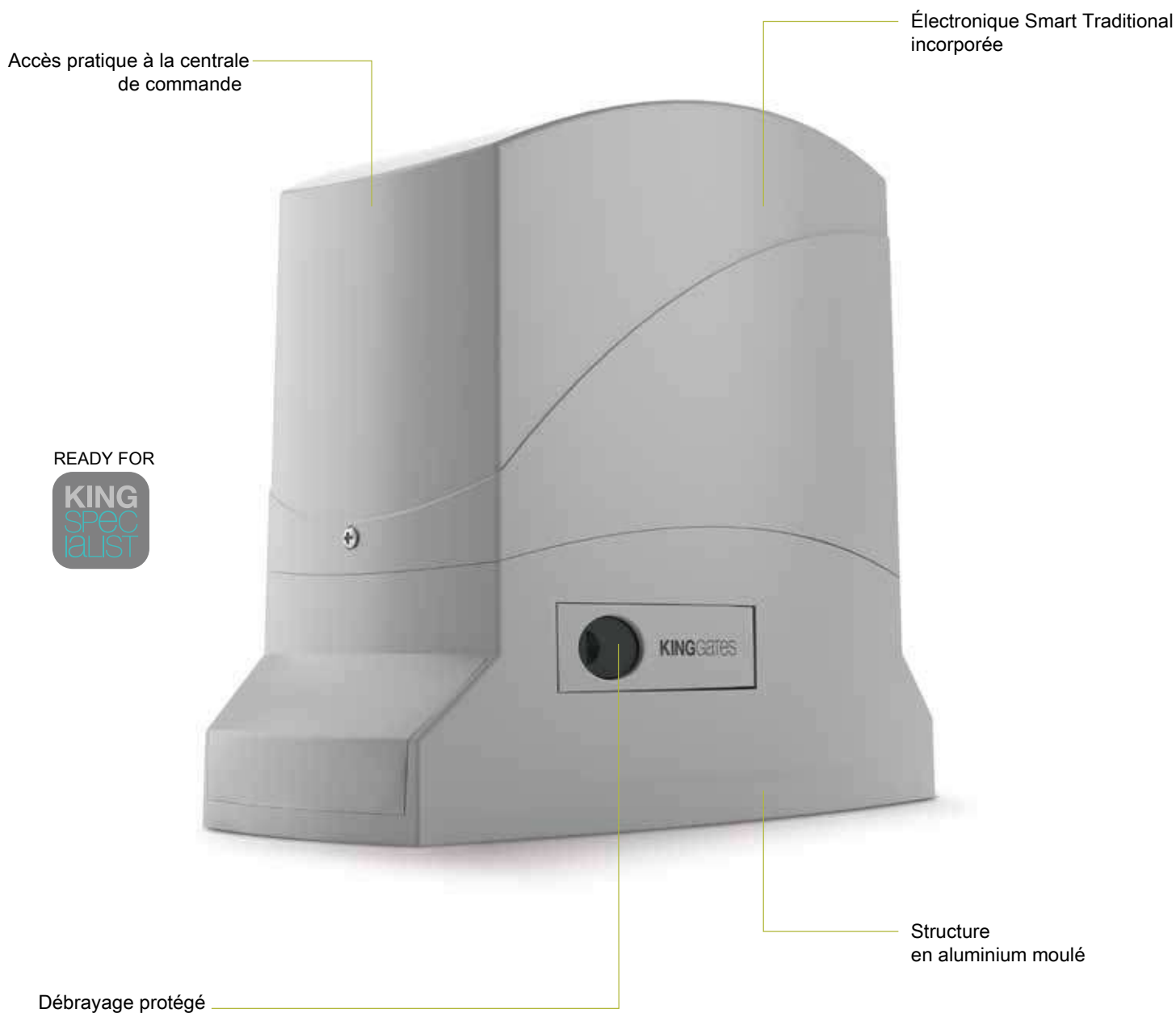

MÉCANIQUE PRÉCISE ET SILENCIEUSE

Fabriqués avec des matériaux résistants, ils couissent sur des roulements à billes de grande dimension qui sont fixés sur des logements à galets en aluminium moulé sous pression. L'engrenage interne est réalisé selon le système de dents à développante : maximalise la surface de contact entre la vis sans fin et l'engrenage, la dent enrôle l'hélice de la vis, alors qu'avec les constructions traditionnelles, la partie en contact n'est que de quelques millimètres.

Résultat : mouvement silencieux, très haut rendement, usure annulée.

DONNÉES TECHNIQUES

DYNAMOS

Code	Moteur	Électronique	Récepteur radio	Kit de fixation	Poids maxi du portail
Dynamos 500	230 Vca	STARG8 AC	•	•	500 kg
Dynamos 1000	230 Vca	STARG8 AC	•	•	1000 kg
Dynamos 24/400	24 Vcc	STARG8 24	•	•	400 kg
Dynamos 24/600	24 Vcc	STARG8 24	•	•	600 kg
Dynamos 24/600F	24 Vcc	STARG8 24	•	•	600 kg
Dynamos 24/1000	24 Vcc	STARG8 24	•	•	1000 kg

DYNAMOS KIT

Code	DYNAMOS 500	DYNAMOS 24/400	DYNAMOS 24/600	STYLO 4K	IDEA PLUS	NOVO LT 24 PLUS	VIKY 30	NOVO PH 180	TAB	Poids maxi du portail
Dy Kit 230/500	•			• (2)	•		•		•	500 kg
Dy Kit 230/500 LT	•			• (1)			•			500 kg
Dy Kit 24/400		•		• (2)	•		•		•	400 kg
Dy Kit 24/400 LT		•		• (1)			•			400 kg
Dy Kit 24/600			•	• (2)	•		•		•	600 kg
Dy Kit 24/600 LT			•	• (1)			•			600 kg
Dy Kit 24/400 NV		•		• (2)		•		•	•	400 kg
Dy Kit 24/600 NV			•	• (2)		•		•	•	600 kg

Version 24 V disponible également pour alimentation secteur 110 V / 60 Hz



DYNAMOS



STYLO 4K



IDEA PLUS



VIKY 30



TAB



NOVO LT 24 PLUS



NOVO PH 180





MiniModus KINGgates

Automatismes pour **portails battant** jusqu'à avec vantaux jusqu'à 2 m - 250 kg

Accès pratique à la logique de commande



FLEXIBILITÉ D'INSTALLATION

MiniModus est l'automatisme à bras articulé pour portails à battants jusqu'à 2 m - 250 kg par vantail.

Avec une largeur de seulement 155 mm, le motoréducteur MiniModus peut être fixé aussi dans des espaces réduits, tandis que la géométrie du bras articulé garantit l'installation également sur de très grands piliers avec une distance entre l'axe du vantail et la surface de fixation du motoréducteur jusqu'à 240 mm.

RÉSISTANT ET COMPACT

MiniModus contient une centrale de commande et un logement pour les batteries qui garantissent le fonctionnement, même après plusieurs heures, suite à une coupure de courant.

La manœuvre de déblocage, comme pour tous les produits KINGgates, est simple et rapide, tandis que la fixation du motoréducteur sur le pilier et sur le portail est rapide et pratique pour l'installateur, grâce aux pattes à visser. En effet, aucune soudure est nécessaire.

MINIMODUS

Code	Moteur	Électronique	Récepteur radio	Butée fins de course	Kit de fixation	Bras articulé	Dimension max vantail
MiniModus SL	24 Vcc	-	-	• (1)	•	•	2 m - 250 kg
MiniModus MA	24 Vcc	STARG8 24	•	• (1)	•	•	2 m - 250 kg

MINIMODUS KIT

Code	MINIMODUS MA	MINIMODUS SL	STYLO 4K	IDEA 24 PLUS	VIKY 30	NOVO LT 24 PLUS	NOVO PH 180	TAB	Dimension max vantail
MiniModus Kit 24	•	•	• (2)	•	•			•	2 m - 250 kg
MiniModus Kit 24 LT	•	•	• (1)		•				2 m - 250 kg
MiniModus Kit 24 NV	•	•	• (2)			•	•	•	2 m - 250 kg

Version 24 V disponible également pour alimentation secteur 110 V / 60 Hz



MINIMODUS MA



MINIMODUS SL



STYLO 4K



IDEA 24 PLUS



VIKY 30

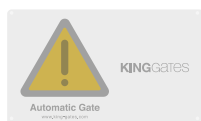

TAB



NOVO LT 24 PLUS



NOVO PH 180

LIMITES D'UTILISATION

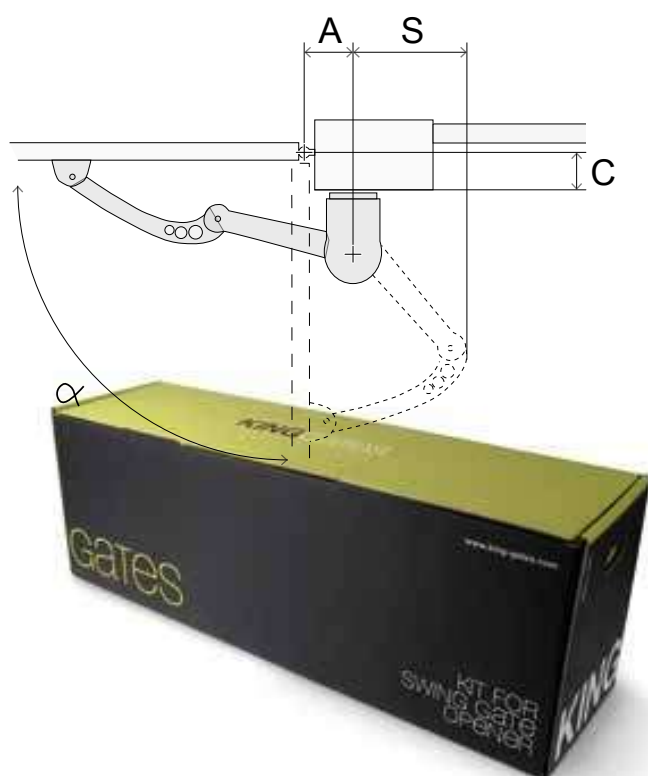

A	C	S	α
130	30	60	95
180	30	110	105
135	60	65	95
195	60	125	105
140	90	70	95
205	90	135	105
140	120	75	95
220	120	155	105
145	150	80	95
230	150	170	105
150	180	85	95
250	180	185	105
165	210	100	95
205	240	170	95

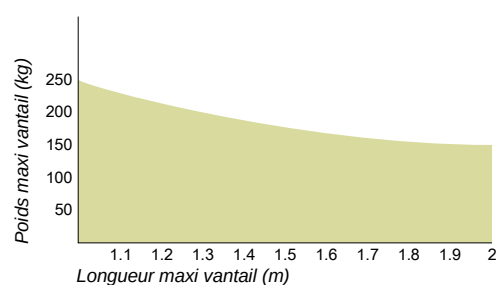
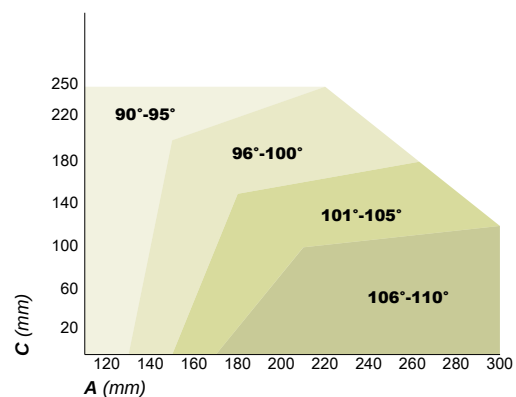

Couper 24 KINGGATES



Automatismes pour **portails battants avec vantaux**
jusqu'à 2 m - 400 kg

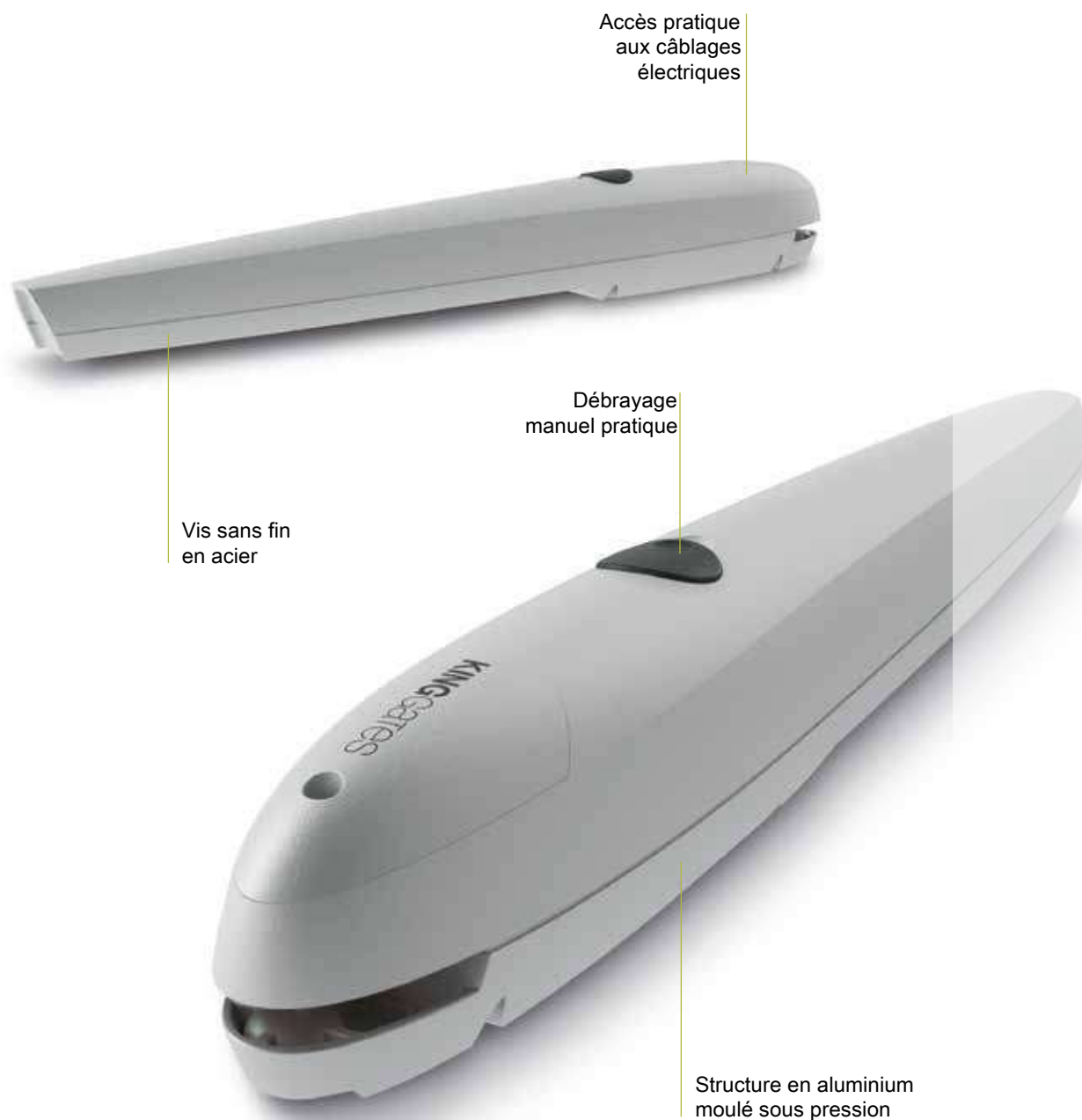

FIABILITÉ MÉCANIQUE

Couper est l'automatisme idéal pour des portails battants avec vantaux jusqu'à 2 m - 400 kg.

La mécanique, placée entre deux solides coques en aluminium moulé sous pression, a été conçue pour garantir de très hautes performances quelque soit l'environnement.

INSTALLATION RAPIDE

Seulement deux câbles pour la connexion électrique de Couper. L'accès au serre-câbles, placé dans la partie supérieure du motoréducteur, facilite le câblage et l'installation. **Le réglage de la course est simple et rapide grâce aux butées mécaniques réglables.**

COUPER 24

Code	Moteur	Fins de course mécaniques	Kit de fixation	Dimension max vantail
Couper 24	24 Vcc	• (1)	•	2 m - 400 kg

COUPER 24 KIT

Code	COUPER 24	STARG8 24 BOX	STYLO 4K	IDEA 24 PLUS	VIKY 30	TAB	Dimension max vantail
Couper Kit 24	• (2)	•	• (2)	•	•	•	2 m - 400 kg
Couper Kit 24 LT	• (2)	•	• (1)		•		2 m - 400 kg

Version 24 V disponible également pour alimentation secteur 50 Hz



COUPER 24



STARG8 BOX



STYLO 4K



IDEA 24 PLUS



VIKY 30



TAB

LIMITES D'UTILISATION

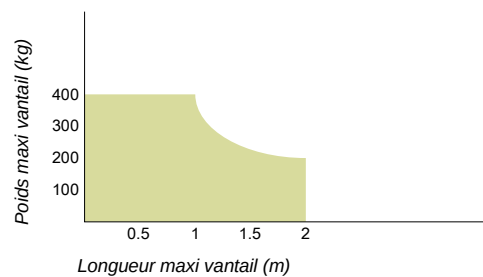
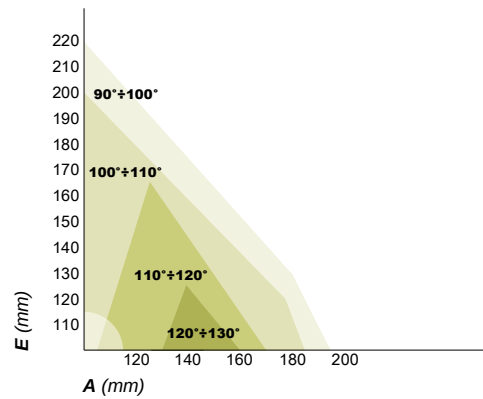
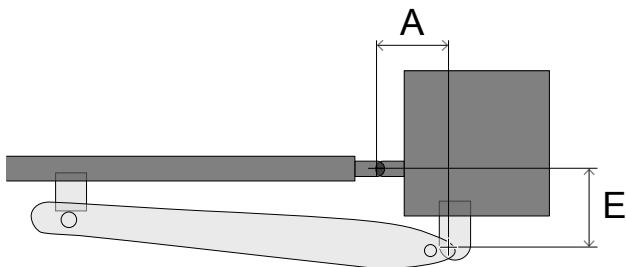

the king specialist



App KINGspecialist pour les professionnels de l'installation

L'App KINGspecialist permet de compléter toutes les phases de configuration de l'installation directement à partir de votre smartphone ou tablette.

Grâce au module wifi à insérer dans la centrale STARG8, les professionnels sont en mesure de gérer toutes les fonctionnalités de l'électronique KING Smart Traditional de façon simple et intuitive.

L'App introduit également de nouvelles fonctionnalités comme la gestion de la maintenance programmée, le check-up de la centrale et la gestion des télécommandes.

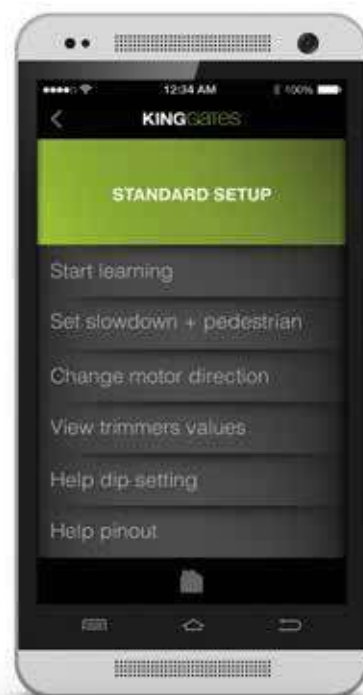

KINGgates compte sur un réseau d'installateurs experts et profs

KINGspecialist est le programme réservé aux profs de l'installation, la qualité déclinée dans le Service. Des innovations installer-friendly et des mises à jour continues afin de se développer ensemble.

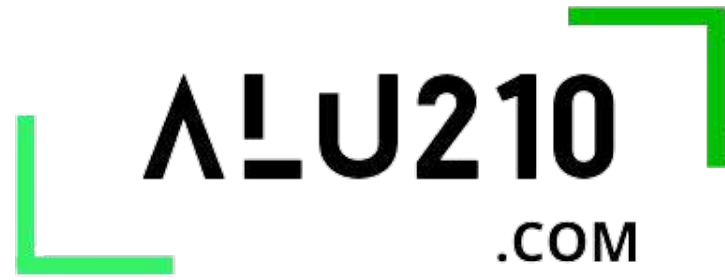

The logo features the text "ALU210" in a bold, black, sans-serif font. Below it, ".COM" is written in a smaller, black, sans-serif font. The text is enclosed within a green L-shaped graphic that forms a partial frame around it.

ALU210
.COM